

# Service Guide

## Winter 2024/25

Valid as of  
27 October  
2024

 **SWISS**  
WorldCargo

# Intro

## Editorial

Dear valued Swiss WorldCargo customer,

It's very nice to e-meet you as the new Head of Swiss WorldCargo, and I'm happy to address you in this Service Guide for Winter 2024-2025.

In 2024, at Swiss WorldCargo it is all about expansion: Getting bigger, better, further, but even closer to you. Intense and eventful months lie behind us. In fact, in the past half year, the Swiss WorldCargo Team has gone above and beyond – literally, up in the sky, and figuratively, with its continuous efforts to offer your cargo even more connections: Global connection, through the three new long-haul destinations that were added to the network (Washington D.C. still served in winter 2024-2025, Seoul and Toronto to come back in summer 2025); and digital connection, thanks to recent partnerships with multiple digital air cargo booking platforms to bring more expert capacity within your digital reach.

Swiss quality is not just about horizontal expansion; vertical improvement, i.e. reinforcing our strengths, is just as important. Swiss WorldCargo recently received the IATA's Center of Excellence for Independent Validators in Pharmaceutical Logistics (CEIV Pharma) re-certification, which recognizes once again our airfreight division's globally consistent and high-quality pharmaceutical handling processes to safeguard your products' integrity. Given our expertise in transporting pharmaceuticals, achieving an IATA CEIV Pharma re-certification for the second time provides evidence of our commitment to quality and safety, and our ability to adhere to the highest compliance and regulatory requirements.

Two other milestones demonstrate that sustainability is a matter of great importance at Swiss WorldCargo: For the first time, the environmental management system of Swiss International Air Lines (SWISS), including Swiss WorldCargo, has been validated under the strict criteria of Europe's Eco-Management and Audit Scheme (EMAS) and has also been certified under the ISO 14001 international norm. Additionally, in collaboration with the Swiss-based company Climeworks, the premium option 'Aviation Tech Pioneer' was launched, which combines 20% CO2 removal through the pioneering technology of direct air capture (DAC) and 80% reduction through the use of Sustainable Aviation Fuel (SAF), making Swiss WorldCargo the first air cargo carrier with an offer that incorporates this innovative solution to decarbonize aviation.

# Intro

## Editorial

I am as enthusiastic about Swiss WorldCargo's achievements so far as I am about further milestones to come. I would like to thank you for your support and long-standing partnership. We look forward to keep providing you with our high-quality, knowledgeable and trusted services.

Our Winter Timetable 2024-2025 will come into effect as of 27 October 2024. Our Service Guide provides you with accurate and comprehensive information about the products and solutions we can offer you, including details on our aircraft and ground-handling partners. Please visit our website [swissworldcargo.com](https://www.swissworldcargo.com) to find out about our latest news.

We look forward to a continued successful partnership and collaboration with you. We care for your cargo.

Kind regards,

Alain Chisari  
Head of Swiss WorldCargo

# Intro

## Contents

### Branded Products

- Modular airfreight services	7
- SWISS General Cargo	8
- SWISS Valuables	9
- SWISS Vulnerables	10
- SWISS Pharma & Healthcare	11
- SWISS Perishables	12
- SWISS Live Animals	13
- SWISS Mail	14
- Product combinability	15

### Transportation Solutions

- Celsius Active	16
- Container Portfolio	17-19
- Celsius Passive	20
- X-Presso	21-22
- Dangerous Goods	23

### Add-on-Services

- Green Choice	24-25
- Home Delivery	26
- Active Tracking Devices	27-29

### Operational

- Overview of other Services	30
- Acceptance cut-off times (export)	31-33
- Delivery times (import)	34-35
- Connecting times (transfer)	36-40

### Fleet

- Boeing 777-300 (77W)	41
- Airbus A340-300 (343)	42
- Airbus A330-300 (333)	43
- Airbus A321-111 (321)	44
- Airbus A321neo (32Q)	45
- Airbus A320-214 (320)	46
- Airbus A320neo (32N)	47
- Airbus A220-100 (221)	48-49
- Airbus A220-300 (223)	50-51
- Embraer 190 (E90)	52-53
- Embraer 190-E2 (290)	54-55
- Embraer 195-E2 (295)	56-57
- Edelweiss Airbus A320-214 (32E)	58

### Unit Load Devices (ULD)

- Overview	59-60
- Detailed information	61-64

### Cooling Unit Load Devices

- Detailed information	65-71
------------------------	-------

### Packagings

- Detailed information	72-73
------------------------	-------

### Insurance

- General information	74
- Goods of all kinds	75-77
- Species (SWISS Valuables)	78-80
- Exclusions and claims	81-82

### Your cargo contacts

83-87
-------

# Intro

## Philosophy

### **A worldwide standard**

SWISS has developed its entire product and service philosophy on the basis of universal Swiss values such as friendliness, punctuality, reliability, safety and security, innovation, tradition, efficiency and the keenest attention to detail. It has done so with the clear aim of being a leading European airline that is active all over the world and is “best in class” in all its business areas – not just for passengers, but for cargo, too.

### **Added value**

Adding value is one of Swiss WorldCargo's paramount objectives. As an internationally-active provider of airfreight capacity, SWISS cargo division creates genuine added value for its customers through its specialist expertise, its commitment to quality and its innovative skills.

# Intro

## Philosophy

### Airport-to-airport

Swiss WorldCargo focuses on globally marketing cargo capacity between two or more airports, and offers an airfreight network that stretches to more than 130 destinations in over 80 countries. Its network of air services is supplemented by daily truck connections between key business centres.

### Flown as planned

With its guaranteed acceptance, transfer and delivery times and its carefully-selected ground handling partners, SWISS WorldCargo offers the firmest of commitments that all your consignments will be transported exactly as they are booked.

### Seamless

Swiss WorldCargo does not market its own logistics concepts: it integrates its services seamlessly and precisely into its customers' supply systems and chains, to ensure that its total attention to safety and security extends to its customers' planning too.

### Supervised

Seamless integration will only be half as effective unless it is combined with continuous monitoring and a swift and proactive response to any irregularities that occur. That's why Swiss WorldCargo provides its "Match" online consignment tracking system for its customers – to let them know in real time exactly where their shipment is currently located on the SWISS network.

### Customer-centric

Swiss WorldCargo makes full use of its extensive experience and expertise to provide innovative concepts that are specifically tailored to its forward-looking customers and their particular airfreight needs.

Swiss WorldCargo offers airfreight products that include SWISS General Cargo, SWISS Valuables, SWISS Vulnerables, SWISS Pharma & Healthcare, SWISS Perishables, SWISS Live Animals and SWISS Mail.

In addition, we offer transportation solutions, such as X-Presso, Celsius Active, Celsius Passive, and Dangerous Goods, and add-ons like Green Choice, Home Delivery, and Active Tracking Devices

For further details, please visit [swissworldcargo.com](http://swissworldcargo.com)

# Branded Products

## Transportation Solutions and Add-on-services

### Modular airfreight services

Swiss WorldCargo addresses the shipping needs of different commodities. We will provide you with flexible, scalable solutions that can be dynamically adapted to the changing needs of your goods.

### Design your own air cargo service tailored to your needs.

#### 1. The What (Products)

Pick from one of our branded products based on the commodity you are transporting.

#### 2. The How (Transportation Solutions)

Select from our transportation solutions how do you wish to transport your shipment.

#### 3. The Extra (Add-on-services)

Customize your shipment with one of our add-on services to match your needs.

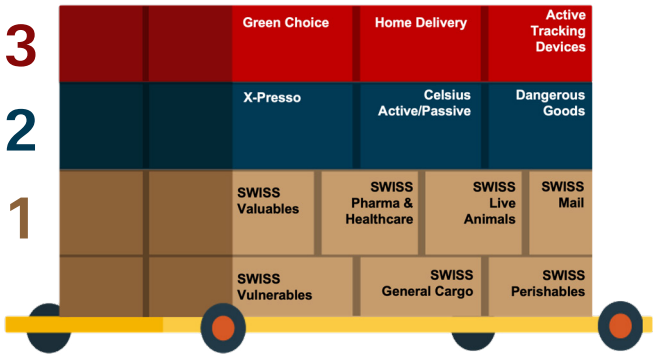

# Branded Products

## SWISS General Cargo



### Let your shipments benefit from Swiss quality and reliability of service

Transporting goods of all kinds requires a high level of accuracy to ensure a reliable transportation service. SWISS General Cargo offers exactly that. You can rely on SWISS quality when we transport your consignment by air or by road. Throughout our global network we can provide excellent service tailored to meet your requirements.

SWISS General Cargo is suitable for any air cargo consignment for which customers require special quality and expertise. We focus on quality, reliability and efficiency, as our flights follow a strict schedule and you can count on our punctuality. **Our reliability. For your quality transportation.**

### Why SWISS General Cargo?

**Global network of excellence:** With our extensive global network, we offer seamless air and truck connections between key business centers worldwide. Whether it's across continents or within a region, count on us to deliver your shipments promptly and efficiently.

**Punctuality at its best:** We take pride in our stable flight schedules and high 'flown as booked' rate ensuring your cargo reaches its destination on time, every time. Trust in our punctuality to keep your supply chain running smoothly.

**Hub in Zurich:** Our state-of-the-art hub in Zurich is designed for seamless integration into your supply chain, allowing for a quick transit time of up to 10 hours. The combination of short distances between the warehouse and aircraft positions, along with top-notch operational and warehouse handling, ensures your cargo is handled with the utmost efficiency and care.

**No weight limitations:** SWISS General Cargo has no weight limitations (subject to aircraft type restrictions), making it the ideal choice for a wide range of cargo shipments.



# Branded Products

## SWISS Valuables

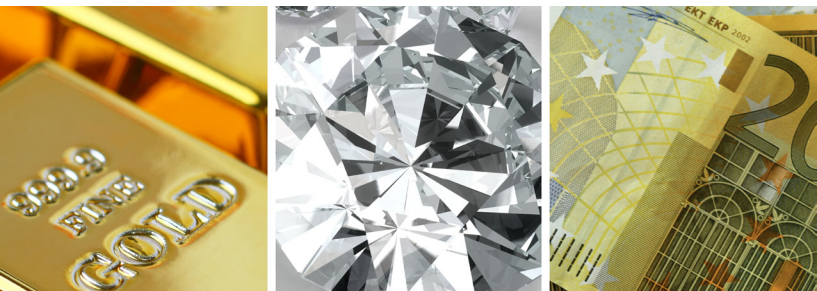

### Premium solution for highly secured cargo transport

The premium solution for your highly secured supply chain. In today's world, valuable consignments encompass more than just traditional assets like gold, money, and precious gems. With the ever-increasing pace of life, there is a growing demand for transporting highly confidential documents, exquisite art pieces, and valuable collections. We understand the importance of mitigating risks associated with transporting high-value cargo. That's why our valuable product surpasses the security standards set by IATA. When you choose us to transport your valuables by air, you can trust in our commitment to upholding Switzerland's time-honored values of discretion, reliability, and technical expertise. **Our discretion. For your shipment's security.**

### Why SWISS Valuables?

**Unrivalled security measures:** Exceeding IATA's security standards, we uphold Switzerland's values of discretion, reliability, and technical expertise, ensuring your valuable cargo is in safe hands. The four-eyes principle is followed during handling, transportation, and aircraft loading/unloading processes, ensuring thorough checks at every stage.

**Discretion at every step:** Benefit from special storage with camera surveillance, sealed containers, and highly secured transport for on-time delivery. We also accept dangerous goods, subject to local restrictions and IATA DG regulations.

**Comprehensive protection:** Our global network follows rigorous handling standards, storing your cargo in constantly monitored facilities, and delivering only to authorized consignees. With SWISS Valuables, you can rely on tarmac escort to and from the aircraft.

**Reliable transportation hub:** Our dedicated secure hub reduces potential risks with a separate and highly secured storage facility. Our Zurich hub offers short turnaround times and meticulous checks at every stage, ensuring efficient and secure transportation.

# Branded Products

## SWISS Vulnerables

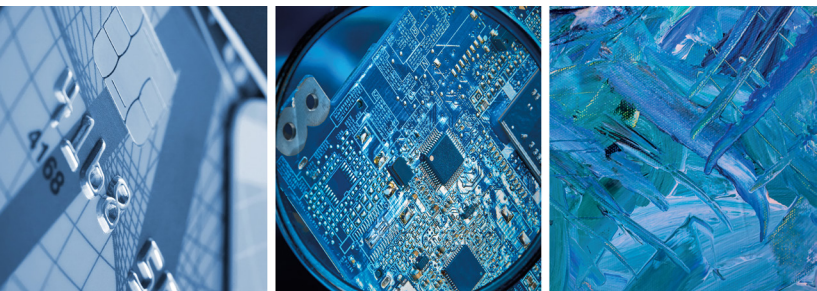

### Protect your shipment without compromise

The hi-tech, the fine art and the high-end fashion and other specialised industries manufacturing complex and delicate products require reliable and protected logistics chains. Careful handling, product integrity, theft prevention, discretion and confidentiality are key requirements when it comes to air freight solutions for these extremely vulnerable products. With SWISS Vulnerables we offer substantially high protection against tempering. **Our caution. For your cargo protection.**

### Why SWISS Vulnerables?

**Enhanced theft protection:** Our distinctive storage facilities come with special attendance and additional security checks both before departure and upon landing, ensuring your cargo's safety throughout the journey.

**Secured transport processes:** Specialised transport and handling processes guarantee that your cargo remains secure en route until its destination.

**Tailored surveillance and loading:** Our dedicated storage, surveillance, and precise loading procedures ensure that your cargo is shielded at every stage of its journey.

**Skilled global personnel:** Our highly trained and skilled personnel across the globe are dedicated to ensuring the security and safety of your shipment.

**Capacity access:** Enjoy preferential access to capacity without weight limitations (subject to aircraft type restrictions), providing you with flexibility and convenience.

**Consistent quality standards:** Benefit from our globally consistent handling and quality standards that reflect our commitment to excellence.

# Branded Products

## SWISS Pharma & Healthcare



### Rely on us to safeguard your product integrity

We recognize the crucial importance of transporting life-saving medicines, temperature-sensitive vaccines, and essential healthcare products with the highest level of precision and care. In a world where freshness, quality, and timeliness are paramount, our tailored airfreight solution ensures that your pharmaceutical and healthcare goods reach their destination in optimal condition. We understand the delicate nature of these commodities and maintain stringent measures to preserve their integrity throughout the entire journey. Trust us for precision and care in transporting your pharmaceutical and healthcare goods, trust our SWISS Pharma & Healthcare product. **Our expertise. For your product integrity.**

### Why SWISS Pharma & Healthcare?

**Customised Approach:** Tailored to your unique needs, our offering provides a reliable and secure transportation solution for your sensitive shipments.

**Temperature Solutions:** Our transportation solutions ensure temperature maintenance throughout the entire transportation chain. Choose the solution that is best fitting your requirements:

- **Celsius Active** for the pharmaceutical temperature-controlled supply chain, demanding the strictest temperature maintenance and active temperature control throughout the entire transportation chain.
- **Celsius Passive** for temperature-sensitive pharmaceutical shipments, requiring temperature support for the storage and transportation at origin, transfer and destination.

**Enhanced Services:** Benefit from prioritized ground handling, the possibility to book express speed, short transit times, high flexibility, preferred flight capacity access, and global quality control.

**Certifications:** We are IATA CEIV Pharma certified as an airline, and our hub in Zurich holds the GDP compliance certification by Swissmedic and IATA CEIV Pharma certification.

**Expert Staff:** Our worldwide trained team provides professional shipment handling, ensuring the highest level of competence.

# Branded Products

## SWISS Perishables



### Trust us to always keep your perishables fresh

In a world where freshness, quality, and timeliness are paramount, the transportation of perishable goods demands utmost precision and expertise. At Swiss WorldCargo, we understand the critical nature of transporting delicate fruits, vegetables, and meats. We ensure your delicate produce maintains its freshness and quality throughout the journey.

We recognize the importance of every minute, and our streamlined supply chain guarantees swift and efficient delivery, minimizing any potential spoilage while adhering to the highest standards of care. **Our efficiency. For your consignments' freshness.**

### Why SWISS Perishables?

**Precision in perishables:** Our team's expertise guarantees that your delicate fruits, flowers, vegetables, fish, seafood and meats remain as fresh as when they were harvested. From handling to transportation, we uphold the highest standards of care.

**Efficiency in every detail:** Benefit from seamless air and truck connections between global business centers. Our processes adhere to countries' regulations and we ensure that documentation is provided according to authorities' requirements.

**Seamless integration:** We seamlessly integrate into your supply chain, ensuring that your shipments move smoothly. Our commitment to high-quality handling standards means your goods are treated with the utmost care and attention.

**Global consistency:** No matter where your goods are headed, our highly skilled personnel worldwide ensure that your perishables receive the same level of care. Our integrated online consignment tracking system keeps you informed every step of the way.

**Hub of excellence:** Our Zurich hub offers dedicated handling and storage for perishables. Short distances between our warehouse and aircraft positions, along with efficient processes, minimize exposure to outside conditions, preserving your goods' quality.

# Branded Products

## SWISS Live Animals

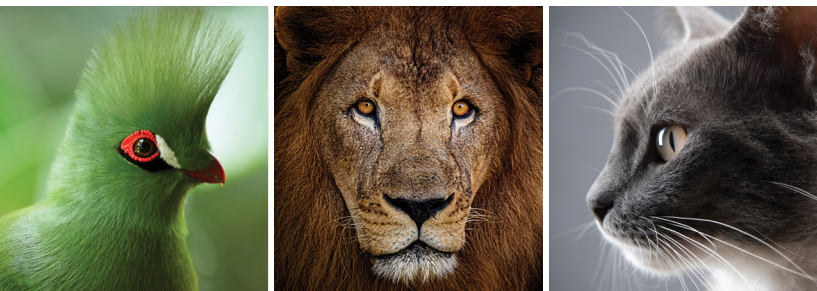

### Entrust your beloved pets and animals to our attentive care for a worry-free journey

SWISS Live Animals is the premium service for transporting live animals with utmost care and expertise. We understand the importance of ensuring the well-being and safety of your precious animals during their journey. With a team of trained experts and specialized facilities, we go above and beyond to provide a seamless and stress-free experience for both you and your animals. Our fast and efficient transportation options, adherence to strict regulations, and commitment to animal welfare make us the preferred choice for transporting a wide range of live animals, including hatching eggs, tropical animals, zoo animals, pets, and more. Trust SWISS Live Animals to deliver exceptional service, peace of mind, and the highest level of care for your beloved companions. **Our care. For your peace of mind.**

### Why SWISS Live Animals?

**Specialized facilities and staff:** The animal center in our Zurich hub is equipped with dedicated staff who are trained to provide maximum care for the animals. From ensuring a stress-free environment to offering water and additional food upon request, the expertise of staff ensures the well-being of the animals throughout their journey.

**Priority and expert handling:** Live animal shipments receive the highest transportation priority, guaranteeing their well-being and timely transportation. Our team follows strict IATA Live Animal Regulations and implements specific handling processes for their safety and comfort.

**Crew attention:** Our crew members prioritize the animals' well-being, maintaining the appropriate ambient temperature for a comfortable journey.

**Constant monitoring:** Our dedicated staff checks on the well-being of the animals at every step of their journey. We prioritize their comfort and safety throughout the transportation process.

# Branded Products

## SWISS Mail



### Deliver mail swiftly in transparency

The airmail parcel business is constantly increasing due to a phenomenal potential market volume and growth for national postal organisations. The worldwide major postal organisations are already prominently active in this high-potential business sector. They are busy ensuring greater vertical integration and control over their operation processes to secure a leading role in the global logistics arena and position themselves to offer integrated international Express Mail Services (EMS), Priority Mail (Airmail) or Non-Priority Mail (S.A.L).

Airmail services have their own special needs – whether they are Express Mail Services (EMS), Priority Mail (Airmail) or Non-Priority Mail (S.A.L) – exemplary efficiency is just as essential as absolute discretion, be it letters or parcels. **Our consistency. For your transparent delivery.**

### Why SWISS Mail?

By choosing SWISS Mail, you benefit from unparalleled transparency, which can transform your business operations positively. Here's how:

**Empowerment:** You now have the ability to provide your end customers with full information, a vital aspect in today's competitive landscape. Transparency builds trust, and we understand how important it is to know exactly where your mail is at any given time.

**Real-time adaptation:** With continuous updates on your mail's current status, you can act swiftly in response to any unforeseen circumstances. Whether it's flight cancellations or backlogs, you have the flexibility to adjust production or re-route traffic temporarily to ensure smooth operations.

# Branded Products

## Product combinability

Transportation Solutions	X-Presso	Celsius Active	Celsius Passive	Dangerous Goods
SWISS General Cargo	✓	✓	✓	✓
SWISS Valuables	X	X	X	✓
SWISS Vulnerables	✓	X	X	✓
SWISS Pharma & Healthcare	✓	✓	✓	✓
SWISS Perishables	✓	✓	✓	X
SWISS Live Animals	✓	X	X	X
SWISS Mail	X	X	X	X

Add-on Services	Green Choice	Direct Delivery	Active Tracking Devices
SWISS General Cargo	✓	✓	✓
SWISS Valuables	✓	X	✓
SWISS Vulnerables	✓	X	✓
SWISS Pharma & Healthcare	✓	✓	✓
SWISS Perishables	✓	✓	✓
SWISS Live Animals	✓	X	✓
SWISS Mail	X	X	X

# Transportation Solutions

## Celsius Active

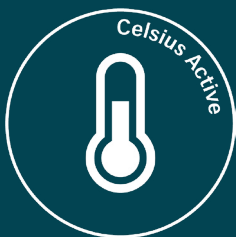

### For your temperature controlled supply chain

The market for pharmaceutical and healthcare products continues to grow and shows a sustainable and sound development. As speed to market is essential, the healthcare industry is increasingly relying on air cargo. The challenge for all the involved parties in the supply chain is to keep healthcare products within the required temperature range to ensure an uninterrupted cool chain and preserve the quality of the product.

Maintaining cool chain integrity is a core element in the transportation of temperature controlled pharmaceutical products. To maintain the product temperature along the supply chain, customers are choosing an 'active' temperature controlled container based on technologies like compressor cooling, electric heating or dry ice refrigeration.

Swiss WorldCargo's Celsius Active is a custom-made, high-quality solution for your shipments that require seamless transportation in active temperature controlled containers.

### Why Celsius Active?

#### Our Product

- Transport in active temperature-controlled containers for consistency in temperature ranges from -20 °C to +20 °C
- Quality control via check sheet at the airport of departure, transfer and arrival
- A global network of selected audited stations
- Thermo truck network available
- Worldwide personnel trained in temperature controlled container handling
- Uniform handling standards worldwide
- Dangerous goods accepted (local restrictions and IATA DG regulations apply)
- Integrated online consignment tracking system



# Transportation Solutions

## Container Portfolio

### Envirotainer

#### **LD9 Envirotainer RAP t2**

Thermostat-controlled heat exchanger with dry ice as refrigerant

Temperature range -20 °C to +20 °C

See technical details on page 65

#### **LD3 Envirotainer RKN t2**

Technology thermostat-controlled heat exchanger with dry ice as refrigerant

Temperature range -20 °C to +20 °C

See technical details on page 65

#### **LD9 Envirotainer RAP e2**

Fully redundant thermostat-controlled air conditioning system with compressor cooling and electrical heating

Temperature range 0 °C to +25 °C

See technical details on page 66

#### **LD9 Envirotainer Releye RAP**

Fully redundant thermostat-controlled air conditioning system with compressor cooling and electrical heating

Temperature range +5 °C and +20 °C

See technical details on page 66

#### **LD11 Envirotainer Releye RLP**

Fully redundant thermostat-controlled air conditioning system with compressor cooling and electrical heating

Temperature range +5 °C and +20 °C

See technical details on page 67

#### **LD3 Envirotainer RKN e1**

Thermostat-controlled compressor cooling and electrical heating

Temperature range 0 °C to +20 °C

See technical details on page 67

# Transportation Solutions

## Container Portfolio

### Sonoco ThermoSafe

#### LD3 ThermoSafe, Pegasus

Advanced passive temperature controlled system

Temperature range +2 °C to +8 °C

See technical details on page 68

### CSafe

#### LD9 CSafe RAP

Thermostatic controlled compressor cooling and electrical storage

Temperature range +4 °C to +25 °C

See technical details on page 69

#### LD3 CSafe RKN

Thermostat-controlled compressor cooling and electrical heating

Temperature range +4 °C to +25 °C

See technical details on page 69

### DoKaSch

#### LD9 DoKasch RAP

Fully redundant thermostat-controlled air conditioning system with compressor cooling and electrical heating

Temperature range +2 °C to +30 °C

See technical details on page 70

#### LD3 DoKasch RKN

Thermostat-controlled compressor cooling and electrical heating

Temperature range +2 °C to +30 °C

See technical details on page 70

# Transportation Solutions

## Container Portfolio

### Swiss Airtainer

#### LD3 Swiss Airtainer RKN

Fully redundant thermostat-controlled air conditioning system with compressor, cooling and electrical heating

Temperature range +5 °C and +25 °C

See technical details on page 71

# Transportation Solutions

## Celsius Passive

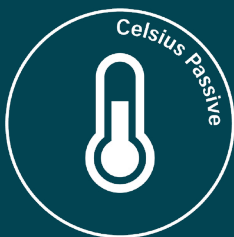

### For your temperature sensitive supply chain

Customers around the globe are investing more and more resources in sophisticated passive packaging solutions for their time and temperature sensitive shipments.

However, it is not all about packaging, these healthcare shipments rely on high quality standardised processes, speed and adequate storage, wherever possible, throughout the supply chain.

### Why Celsius Passive?

#### Our Product

- Choice between the four official IATA temperature ranges: controlled frozen (FRO -20 °C), controlled cool (COL +2 °C to +8 °C), controlled room temperature (CRT +15 °C to +25 °C) and controlled extended room temperature (ERT +2 °C to +25 °C) as well as ambient storage
- A global network of selected audited stations
- Thermo truck network available
- Skilled and trained personnel worldwide
- Uniform handling and quality standards worldwide
- Dangerous goods accepted (local restrictions and IATA DG regulations apply)
- Integrated online consignment tracking system

# Transportation Solutions

## X-Presso



### For your time-critical supply chain

When time is of the essence, trust X-Presso to deliver your shipments with unrivaled speed and precision. We understand the importance of urgent deliveries in today's fast-paced world, and that's why we've developed X-Presso – a transportation solution designed to meet your time-critical supply chain needs. With X-Presso, you can enjoy blazing-fast transit times, dedicated handling processes, and seamless integration with your existing products. Say goodbye to long shipping delays and embrace the power of X-Presso for your express shipping requirements. No matter the nature of your cargo, X-Presso enables faster shipping, freeing you from limitations based on the commodity type.

### Why X-Presso?

#### Our Product

- Extremely short acceptance, transfer and delivery times
- Short notice reservations right up to the final acceptance deadline
- Skilled personnel worldwide
- Guaranteed space confirmation shortly before departure
- Globally consistent handling and quality standards
- No weight limitations (aircraft type restrictions apply)
- Globally consistent handling and quality standards
- An integrated online consignment tracking system

# Transportation Solutions

## X-Presso

### X-Presso facts

Capacity Features	X-Presso (XPS)	X-Presso XL (XPL)	X-Presso 'One Hour Option' (XPT)
<b>Preferred space access</b>	Yes Intercontinental: 200 kg/1 m <sup>3</sup> Europe: depends on aircraft type	Yes Worldwide: 500 kg/2.5 m <sup>3</sup> depends on aircraft type	Yes Intercontinental: 200 kg/1 m <sup>3</sup> Europe: depends on aircraft type
<b>Booking tolerance</b>	+/-20%	+/-20%	+/-20%
<b>Maximum weight/m<sup>3</sup> per consignment</b>	Depends on aircraft type	Depends on aircraft type	500 kg/2.5 m <sup>3</sup> per inbound flight
<b>Maximum weight per piece</b>	50 kg	No limits	99 kg for loose shipments
<b>Maximum dimensions per item</b>	depends on aircraft type	depends on aircraft type	depends on aircraft type
<b>BUP</b>	Yes	Yes, except BUP with dangerous goods	Yes
<b>Transport of special cargo (AVI, DGR, etc.)</b>	No, except following Dangerous Goods: RRE, REQ, RDS, MAG, ELI and ELM (without dry-ice)	Yes	No, except following Dangerous Goods: RRE, REQ, RDS, MAG, ELI and ELM (without dry-ice)
<b>Trucks services</b>	Yes	Yes	Yes

Handling features	X-Presso (XPS)	X-Presso XL (XPL)	X-Presso 'One Hour Option' (XPT)
<b>Latest acceptance times "ready for carriage"</b>	90 min *	120 min * for loose items For dangerous goods and live animals, special acceptance conditions apply	90 min for XPS in combination with XPT 120 min for XPL in combination with XPT
<b>Transfer times</b>	90 min *	120 min *	60-89 min for XPS in combination with XPT 60-119 min for XPL in combination with XPT
<b>Delivery times after landing</b>	90 min *	120 min *	90 min for XPS in combination with XPT 120 min for XPL in combination with XPT
<b>Special consignment labeling by the customers</b>	X-Presso tags and stickers	X-Presso tags and stickers	X-Presso tags and stickers
<b>Separate handling process</b>	Yes	Yes	Yes

\* Local offers may differ from standard service. Local conditions may apply.

# Transportation Solutions

## Dangerous Goods



### **Care and expertise: Efficiently, quickly, safely and securely**

Dangerous goods in the air cargo industry are articles or substances that are capable of posing a risk to health, safety, property or the environment, and which are regulated and classified in the IATA Dangerous Goods Regulations. When it comes to shipping dangerous goods, shippers have to be fully aware and trained of what it entails, because ultimately, they are responsible for:

- Understanding restrictions pertaining to shipped dangerous goods
- Selecting the relevant compliant and safe packaging
- Labelling and marking dangerous goods as per IATA regulation
- Correctly completing the relevant documentation

Every year we transport around 16'000 tonnes of dangerous goods on board of our aircrafts. And thanks to our many years of expertise and our fully trained staff, we can grant you peace of mind in full compliance with the ICAO and IATA rules and regulations. You can rely on our knowledge and expert advice for booking, handling and transporting dangerous goods, because we care for your cargo.

### **Dangerous Goods compliance with regulations**

- Compliance to the highest and latest safety & environmental standards
- Dedicated process to accept and handle dangerous goods, with specific acceptance times
- Extensive network
- Tracking system for additional peace of mind
- Fully trained staff worldwide. All personnel worldwide involved in dangerous goods handling are checked and monitored, whether their training is either certified by the local Civil Aviation Authorities or by IATA

# Add-on-Services

## Green Choice



### For your shipments with reduced carbon emissions

We are committed to offering more sustainable options to meet your shipping needs. With Green Choice, you can reduce the CO<sub>2</sub> emissions of your shipments through the purchase of Sustainable Aviation Fuel (SAF) or you can reduce the generated emissions by investing in climate protection projects.

### Choose your compensation package

Discover our range of compensation packages designed to help you or your customers reduce CO<sub>2</sub> emissions of your goods, available at both the Airwaybill (AWB) level and in bulk. We offer flexible options that allow you to choose the level of Sustainable Aviation Fuel (SAF) and CO<sub>2</sub> offsetting into climate protection projects that best suits your needs. Whether you prefer compensating on individual AWBs or consolidating multiple shipments under a bulk agreement, we have the right solution for you. Take a closer look at our packages below:

#### AWB Level Compensation

Choose from three Green Choice options available for every shipment with an AWB. Ensure to book the compensation before shipment departure.

- Option 1: 80% SAF and 20% CO<sub>2</sub> offsetting
- Option 2: 40% SAF and 60% CO<sub>2</sub> offsetting
- Option 3: 20% SAF and 80% CO<sub>2</sub> offsetting
- Option 2: 10% SAF and 90% CO<sub>2</sub> offsetting
- Option 3: 100% CO<sub>2</sub> offsetting

The AWB compensation applies to the entire routing and the final shipped gross weight of the shipment. Partial routing or partial shipment weight compensation is not possible, and fixed amount compensation is also not available.



# Add-on-Services

## Green Choice



### Bulk Agreement

This leads to a maximum CO<sub>2</sub> reduction through SAF of 80% (no overcompensation) and an offset of the remaining 20% through investing in climate protection projects. In case your customer is interested in other carbon reduction options, we can look into this and find a solution.

In addition, with the option of buying SAF, customers can contribute to their own sustainability targets. For the bought SAF, customers get an independently audited certificate of the reduced amount that they can use for reaching their target of emissions reduction in their Scope 3 carbon report.

# Add-on-Services

## Home Delivery



### For your peace of mind up to your warehouse

With our competitive network of trucks and a centralized hub in Zurich, Europe, we ensure a seamless connection from arrival to your final destination. The Home Delivery option can be added to the transportation of temperature-sensitive products, and our trucks are equipped with different temperature settings for optimal care.

Experience the benefits of our value proposition, including direct delivery to your own warehouse, temperature-controlled trucking vehicles, and short transfer and delivery times aligned with flight schedules. Choose between regular home delivery or ad-hoc options. Say goodbye to long waiting times and broken cold chains: our prompt truck arrangements and on-time deliveries with the required temperature ensure your cargo's safety.

### Streamlined delivery solutions tailored to your needs

- Direct delivery to your warehouse
- Competitive network of trucks with a centralized hub in Zurich, Europe
- Flexibility to choose between regular home delivery booking or ad-hoc options
- Seamless connection from arrival to final destination
- Ability to combine with temperature-sensitive products
- Trucks equipped with different temperature settings
- Quality Management system ensuring continuous improvement and risk mitigation
- Efficient internal processes to prevent irregularities
- Knowledgeable customer service team available for inquiries
- Experienced support team for handling irregularities and issues

# Add-on-Services

## Active Tracking Devices



### For keeping control of your goods at all times

The need for timely information and transparency is a key requirement in supply chain logistics, since any number of cargo irregularities can occur during transportation, despite careful planning.

That is why we allow the transportation of SWISS-approved active tracking devices (ATDs). Additionally, we provide a 24/7 dedicated intervention team able to react to any ATD deviation alarm worldwide based on your request.

The use of any ATD listed below requires the customer to book their shipment with the SHC of EMD.

IATA regulations on lithium batteries are in effect, if more than 2 devices per package or more than 2 packages containing such devices, all packages containing such devices must be marked with the lithium battery mark and the «Nature and quantity of Goods Box» on the AWB must show the words «Lithium ion batteries in compliance with Section II of PI 967».

### Contact

You will find your regional contact on our website at [swissworldcargo.com](http://swissworldcargo.com)

# Add-on-Services

## Active Tracking Devices

### Active Tracking Devices

The need for timely information and transparency is a key requirement in supply chain logistics, since any number of cargo irregularities can occur during transportation, despite careful planning.

That is why we allow the transportation of SWISS-approved active tracking devices (ATDs). Additionally, we provide a 24/7 dedicated intervention team able to react to any ATD deviation alarm worldwide based on your request.

The use of any ATD listed below requires the customer to book their shipment with the SHC of EMD.

IATA regulations on lithium batteries are in effect.

- 7P Solutions GD100/GL300/GL300W  
(SWC authorizes the GL300series ONLY WITHOUT external extended batteries)
- ASPION loggers (all models)
- BeeSense Flex\* \*
- BeOn A1
- Berlinger Smart Monitor SHIP L / Berlinger Smart Monitor SHIP S
- Berlinger SmartMonitor SHIP M\*
- Berlinger SmartPoint
- Bosch TDL 140
- Calamp SC1102/SC1004\*
- CargoSense - Toshiba Environmental Logger
- Cartasense U-Sensor
- Controlant CO 10.01
- Controlant Saga\* \*, Saga-H\* \*, and Saga-P\* \*
- ELPRO LIBERO Cx series
- ELPRO LIBERO GE, GL, GS, GH\*
- ELPRO LIBERO GF
- Copeland GO Real-Time Tracker(s), inc 4G/5G LT and 4G/5G GLOBAL versions
- Copeland GO Real-Time Tracker(s), inc 4G/5G LT versions and GO Bluetooth Plus Loggers
- Frigga T7, Frigga B9x and V5 series
- Hanhaa Parcelive
- HERE Premier Tracker
- Hive-Zox - BEEconIoT\* \*
- HiveTracker BEEconIoT with Probe
- Honeywell Gateway/Sensor Tags
- Hyunsung - Smart Label HS-SL815\*
- Intelyt iTAG, Intelyt iCHIME
- Kelvin Pro /Track IT, Kelvin S100, M200 & M300
- Kirschen Global Security A-Type "Schenker Smartbox" Brieftrace
- Kizy K-2 Tracker
- KN Blue Sensor
- Kylos Air
- Lansmont\_Saver\_3X90\* (if using alkaline battery option)

# Add-on-Services

## Active Tracking Devices

- Modum MODsense T
- Monilog® EnDaL smart\*\*\* and MSD
- OnAsset Sentry 500 & Sentry 600 Flightsafe and Sentinel 100 & 100C
- Roambee Bee and BeeSense Air\*
- Roambee - BeeSense Modbus
- Sendum PT300D/PT300
- SenseAware 3000 and SenseAware M4 & ID tag
- Shipit
- SIT1002 tracker
- Sony VT-G100
- STRACKER Single Use PT35
- System Loco E4BL Bluetooth Temp/Humidity Data Logger
- System Loco HGD4 Temp Data Logger, GPS Tracker (alkaline)\*
- T11013050 / TTGEO Ultra Alkaline\*
- T11013070 / TTGEO Ultra Dry Ice Alkaline\*
- Tec4Med CryoBeacon / SmartBeacon / TempBeacon
- TempTale GEO X (T11013210)
- TempTale GEO XE (T11013220)
- TempTale GEO XP (T11013230)
- TempTale GEO XEP (T11013240)
- Tive Solo 5G 7000 (lithium) / Tive Solo 5G 7100 (non-lithium)\*\*
- ToolLive TL001
- Trackonomy FBB-2000 / Trackonomy FWB-2000
- Visilion Mobiam Tracker
- 7P GL300 series (SWC authorizes the GL300series ONLY WITHOUT external extended batteries)

(Last update: October 2023)

\* AWB must include statement "Not restricted. Alkaline IATA DGR special provision SP A123." and "Not restricted as per Special Provision A123."

\*\* AWB must include statement "Not restricted as per DGR Special Provision A199."

Note: According to IATA DGR 1.3, DG documentation and marking is the shipper's responsibility. Should a shipper decide not to take advantage of the new exception in IATA DGR SP A220 and deliver a consignment documented, marked or labeled as ELI or ELM, then a formal DG acceptance check sheet in accordance with LX CHM 6.1.12.1.1 / 6.1.12.3 must be issued upon cargo acceptance.

Note: As per IATA Dangerous Goods Regulations (DGR) 2021 Addendum A220. Packages containing COVID-19 pharmaceutical accompanied by data logger and or cargo tracking devices containing lithium batteries are not subject to the marking and documentation requirements of Section II Packaging Instruction 967 or 970, as applicable. This same package configuration, when consigned without the COVID-19 pharmaceutical for use or reuse, is also not subject to the marking and documentation requirements of Section II Packaging Instruction 967 or 970, providing prior arrangements have been made with the operator. Please contact your local Swiss WorldCargo office for information on repositioning empty packaging(s) that have real time tracking devices.

For an updated list of approved devices, please check our homepage [swissworldcargo.com/en/activetrackingdevices](https://swissworldcargo.com/en/activetrackingdevices)

# Operational

## Overview of other Services

### **Baggage shipped as Cargo**

Do you have larger amounts of excess baggage? Send them with Swiss WorldCargo, the ideal solution for the transport of oversized and heavy baggage, bicycles, bulky goods, furniture etc. Please note the special acceptance deadlines.

### **Live Animals accompanying passenger**

We do allow cats and dogs to travel with their owners in the cabin on most of the SWISS operated flights if the weight including the soft-sided bag does not exceed 8 kilogrammes. Otherwise, they may be transported in the hold as checked baggage or cargo.

# Operational

## Acceptance cut-off times (export)

<b>Zurich</b>		<b>All contents in minutes</b>		
		<b>Narrow</b>	<b>Wide</b>	<b>Truck</b>
<b>Branded Products &amp; Transportation Solutions</b>				
<b>SWISS General Cargo</b>		180	240	240
<b>SWISS Valuables</b>				
Generally		90	90	90
Metals / goldbars / grains		120	120	120
<b>SWISS Vulnerables</b>		180	240	240
<b>SWISS Pharma &amp; Healthcare</b>		180	240	240
<b>SWISS Perishables</b>		180	240	240
<b>SWISS Live Animals</b>		120	120	n/a
<b>X-Presso</b>				
<b>XPS</b>	< 50 kg/piece	90	90	90
<b>XPL</b>	> 50 kg/piece	120	120	120
<b>XPL</b>	With Dangerous Goods (DG)	120	120	120
<b>Celsius Active</b>		n/a	150	150
<b>Celsius Passive</b>		180	240	240
<b>Dangerous Goods</b>		Add 60	Add 60	Add 60
As SWISS General Cargo / SWISS Valuables / SWISS Vulnerables / SWISS Pharma & Healthcare / SWISS Perishables				
<b>Security checks (Screening, hand search, sniffing, etc.)</b>		Add 60	Add 60	Add 60

If X-Presso Transportation Solution is combined with SWISS Live Animals or Dangerous Goods, the shipment needs to be booked with a special handling code XPL.

# Operational

## Acceptance cut-off times (export)

<b>Basel</b>		<b>All contents in minutes</b>		
<b>Branded Products &amp; Transportation Solutions</b>		<b>Narrow</b>	<b>Wide</b>	<b>Truck</b>
<b>SWISS General Cargo</b>		n/a	n/a	120
<b>SWISS Valuables generally</b>		n/a	n/a	90
<b>SWISS Vulnerables</b>		n/a	n/a	120
<b>SWISS Pharma &amp; Healthcare</b>		n/a	n/a	120
<b>SWISS Perishables</b>		n/a	n/a	120
<b>SWISS Live Animals</b>		n/a	n/a	n/a
<b>X-Presso</b>				
<b>XPS</b>	< 50 kg/piece	n/a	n/a	n/a
<b>XPL</b>	> 50 kg/piece	n/a	n/a	90
<b>Celsius Active</b>		n/a	n/a	90
<b>Celsius Passive</b>		n/a	n/a	120
<b>Dangerous Goods</b>		n/a	n/a	Add 60
<b>Security checks (Screening, hand search, sniffing, etc.)</b>		n/a	n/a	Add 60
<b>Geneva</b>		<b>All contents in minutes</b>		
<b>Branded Products &amp; Transportation Solutions</b>		<b>Narrow</b>	<b>Wide</b>	<b>Truck</b>
<b>SWISS General Cargo</b>		90	180	180
<b>SWISS Valuables generally</b>		90	120	n/a
<b>SWISS Vulnerables</b>		90	180	180
<b>SWISS Pharma &amp; Healthcare</b>		90	180	180
<b>SWISS Perishables</b>		90	180	180
<b>SWISS Live Animals</b>		180	180	n/a
<b>X-Presso</b>				
<b>XPS</b>	< 500 kg	50	50	n/a
<b>XPL</b>	> 500 kg	90	90	90
<b>XPL</b>	(except A320)	n/a	120	120
<b>Celsius Active</b>		n/a	120	120
<b>Celsius Passive</b>		90	180	180
<b>Dangerous Goods</b>		Add 60	Add 60	Add 60
<b>Security checks (Screening, hand search, sniffing, etc.)</b>		Add 60	Add 60	Add 60



# Operational

## Acceptance cut-off times (export)

<b>Berne (City Cargo Terminal)</b>		<b>All contents in minutes</b>		
<b>Branded Products &amp; Transportation Solutions</b>		<b>Narrow</b>	<b>Wide</b>	<b>Truck</b>
<b>SWISS General Cargo</b>		n/a	n/a	90
<b>SWISS Valuables generally</b>		n/a	n/a	90
<b>SWISS Vulnerables</b>		n/a	n/a	90
<b>SWISS Pharma &amp; Healthcare</b>		n/a	n/a	90
<b>SWISS Perishables</b>		n/a	n/a	90
<b>SWISS Live Animals</b>		n/a	n/a	n/a
<b>X-Presso</b>				
<b>XPS</b>	< 50 kg/piece	n/a	n/a	90
<b>XPL</b>	> 50 kg/piece	n/a	n/a	90
<b>Celsius Active</b>		n/a	n/a	n/a
<b>Celsius Passive</b>		n/a	n/a	90
<b>Dangerous Goods</b>		n/a	n/a	Add 15
<b>Security checks (Screening, hand search, sniffing, etc.)</b>		n/a	n/a	n/a

# Operational Delivery times (import)

<b>Zurich</b>		<b>Earliest time ready for pick-up All contents in minutes after ATA</b>	
<b>Branded Products &amp; Transportation Solutions</b>	<b>Documents</b>		<b>Goods</b>
<b>SWISS General Cargo</b>	Narrowbody	90	240
<b>SWISS Vulnerables</b>	Widebody	90	360
<b>SWISS Pharma &amp; Healthcare</b>	Truck	90	360
<b>SWISS Valuables</b>	Generally	90	90
<b>SWISS Perishables</b>	Flights ATA until 06:30h	90	11:00h
	Flights ATA 10:30-11:15h	90	15:45h
<b>SWISS Live Animals</b>		90	120
<b>X-Presso</b>			
<b>XPS</b>	< 50 kg/piece	90	90
<b>XPL</b>	> 50 kg/piece	90	120
<b>Celsius Active</b>		90	120
<b>Celsius Passive</b>	Narrowbody	90	240
	Widebody	90	360
	Truck	90	360

<b>Basel</b>		<b>Earliest time ready for pick-up All contents in minutes after ATA</b>	
<b>Branded Products &amp; Transportation Solutions</b>	<b>Documents</b>		<b>Goods</b>
<b>SWISS General Cargo</b>	Narrowbody	n/a	n/a
<b>SWISS Vulnerables</b>	Widebody	n/a	n/a
<b>SWISS Pharma &amp; Healthcare</b>	Truck	60	180
<b>SWISS Perishables</b>			
<b>SWISS Valuables</b>	Generally	60	90
<b>SWISS Live Animals</b>		n/a	n/a
<b>X-Presso</b>			
<b>XPS</b>	< 50 kg/piece	60	90
<b>XPL</b>	> 50 kg/piece	60	120
<b>Celsius Active</b>		60	180
<b>Celsius Passive</b>	Narrowbody	n/a	n/a
	Widebody	n/a	n/a
	Truck	60	180

# Operational Delivery times (import)

<b>Geneva</b>	<b>Earliest time ready for pick-up All contents in minutes after ATA</b>		
<b>Branded Products &amp; Transportation Solutions</b>	<b>Documents</b>	<b>Goods</b>	
<b>SWISS General Cargo</b>	Narrowbody	120	120
<b>SWISS Vulnerables</b>	Widebody	180	180
<b>SWISS Pharma &amp; Healthcare</b>	Truck	100	100
<b>SWISS Perishables</b>			
<b>SWISS Valuables</b>	generally	120	120
<b>SWISS Valuables</b>		90	120
<b>SWISS Live Animals</b>		90	120
<b>X-Presso</b>			
<b>XPS/XPL</b>	loose 1-500 kg	50	50
<b>XPS/XPL</b>	loose > 500 kg	50	60
<b>XPS/XPL</b>	palletised	50	80
<b>Celsius Active</b>		180	180
<b>Celsius Passive</b>	Narrowbody	120	120
	Widebody	180	180
	Truck	100	100

<b>Berne (City Cargo Terminal)</b>	<b>Earliest time ready for pick-up All contents in minutes after ATA</b>		
<b>Branded Products &amp; Transportation Solutions</b>	<b>Documents</b>	<b>Goods</b>	
<b>SWISS General Cargo</b>	Narrowbody	n/a	n/a
<b>SWISS Vulnerables</b>	Truck	60	90
<b>SWISS Pharma &amp; Healthcare</b>			
<b>SWISS Perishables</b>			
<b>SWISS Valuables</b>	generally	60	90
<b>SWISS Live Animals</b>		n/a	n/a
<b>X-Presso</b>			
<b>XPS</b>	< 50 kg	60	90
<b>XPL</b>	> 50 kg	60	90
<b>Celsius Active</b>		n/a	n/a
<b>Celsius Passive</b>	Narrowbody	n/a	n/a
	Truck	60	90

# Operational

## Connecting times (transfer)

### SWISS General Cargo / SWISS Pharma & Healthcare / SWISS Perishables

<b>Zurich</b>				
From	To	Narrowbody and bulk	320, 321	Widebody and truck
Narrowbody and Bulk		360 min	360 min	600 min
320, 321		360 min	360 min	600 min
Widebody and Truck		600 min	600 min	600 min

Note:

Through units generally 120 min

Through units "One Hour Option" 90 min

<b>Basel</b>				
From	To	Narrowbody and bulk	320, 321	Widebody and truck
Truck		180 min	180 min	360 min

<b>Geneva</b>				
From	To	Narrowbody and bulk	320, 321	Widebody and truck
Narrowbody		90 min	90 min	90 min
Truck		180 min	180 min	180 min
Widebody		180 min	180 min	180 min

# Operational

## Connecting times (transfer)

### SWISS Valuables

Zurich	
From	To
All aircraft	All aircraft
	90 min

Geneva	
From	To
All aircraft	All aircraft
	90 min

### SWISS Vulnerables

Zurich				
From	To	Narrowbody and bulk	320, 321	Widebody and truck
Narrowbody and Bulk		300 min	300 min	480 min
320, 321		300 min	300 min	480 min
Widebody and Truck		480 min	480 min	480 min

Basel				
From	To	Narrowbody and bulk	320, 321	Widebody and truck
Narrowbody		75 min	180 min	360 min
Truck		180 min	180 min	360 min
Widebody		360 min	360 min	360 min

Geneva				
From	To	Narrowbody and bulk	320, 321	Widebody and truck
Narrowbody		90 min	90 min	90 min
Truck		180 min	180 min	180 min
Widebody		180 min	180 min	180 min

# Operational Connecting times (transfer)

## SWISS Live Animals

Zurich	
From	To
All aircraft	All aircraft
	120 min

Geneva	
From	To
All aircraft	All aircraft
	120 min

## X-Presso

Zurich		
	All aircraft	Truck
X-Presso	90 min	90 min
X-Presso XL	120 min	120 min

Basel			
	Narrowbody	Widebody	Truck
X-Presso	30 min	90 min	90 min
X-Presso XL	120 min	120 min	120 min

Geneva		
	All aircraft	Truck
X-Presso	90 min	90 min
X-Presso XL	120 min	120 min

# Operational

## Connecting times (transfer)

### Celsius Active

Zurich				
From	To	Narrowbody and bulk	320, 321	Widebody and truck
Narrowbody and Bulk		n/a	n/a	n/a
320, 321		n/a	n/a	n/a
Widebody and Truck		n/a	n/a	120 min

Basel				
From	To	Narrowbody and bulk	320, 321	Widebody and truck
Truck		n/a	n/a	120 min

Geneva				
From	To	Narrowbody and bulk	320, 321	Widebody and truck
Narrowbody		n/a	n/a	n/a
Truck		n/a	n/a	n/a
Widebody		n/a	n/a	120 min

# Operational Connecting times (transfer)

## Celsius Passive

<b>Zurich</b>				
From	To	Narrowbody and bulk	320, 321	Widebody and truck
Narrowbody and Bulk		360 min	360 min	600 min
320, 321		360 min	360 min	600 min
Widebody and Truck		600 min	600 min	600 min

Note:

Through units generally 120 min

Through units "One Hour Option" 90 min

<b>Basel</b>				
From	To	Narrowbody and bulk	320, 321	Widebody and truck
Truck		180 min	180 min	360 min

<b>Geneva</b>				
From	To	Narrowbody and bulk	320, 321	Widebody and truck
Narrowbody		90 min	90 min	90 min
Truck		180 min	180 min	180 min
Widebody		180 min	180 min	180 min



# Fleet

## Boeing 777-300ER (77W)

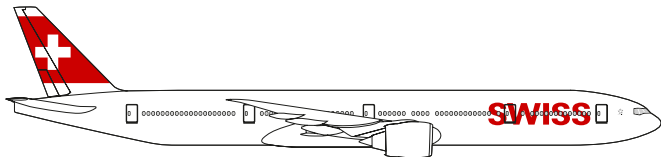

### Area of operation

North and South America, Asia

### Capacity for cargo and mail

Up to 25 tons with full passenger load

### Weight and volume limitations

Compartments		1	2	3	4	5 Bulk	Security locker
Capacity	kg	15483	25838	23132	10322	2721	50
Combined max.	kg	40823		23151			
Volume	m <sup>3</sup>	94		90.6		16.99	0.04
Number of units		2C/2P	5P	12C	4C/1P		

Note: Max. weight per pallet 88 x 125" is 4625 kg, for pallet 96 x 125" 5100 kg.  
Variable pallet, container configuration.

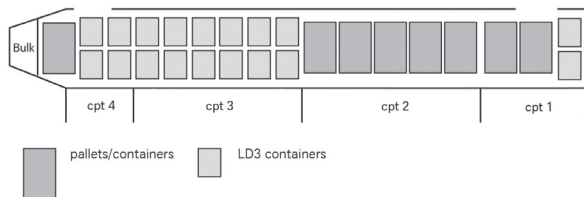

### Basic allocation for cargo and mail

8 pallets/containers

10 LD3 containers

# Fleet

## Airbus A340-300 (343)

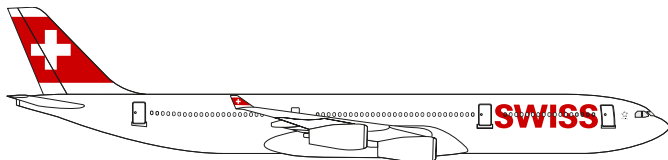

### Area of operation

North and South America, Africa, Middle East, Asia

### Capacity for cargo and mail

Up to 22 tons with full passenger load

### Weight and volume limitations

Compartments		1	2	3	4	5 Bulk	Security locker
Capacity	kg	10206	20412	14832	11619	1881	7
Combined max.	kg	22861		18507			
Volume	m <sup>3</sup>	80.5		62.5		12.0	0.04
Number of units		6 C	4 P	6 C 1 P	7 C		

Note: Max. weight per pallet 88 × 125" is 4625 kg, for pallet 96 × 125" 5100 kg.

Section 52 is occupied by an additional container position (44L).

Variable pallet, container configuration.

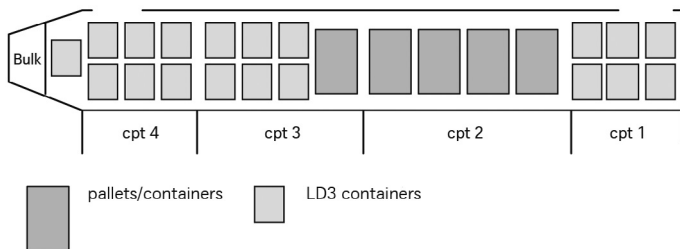

### Basic allocation for cargo and mail

5 pallets/containers

10 s

# Fleet

## Airbus A330-300 (333)

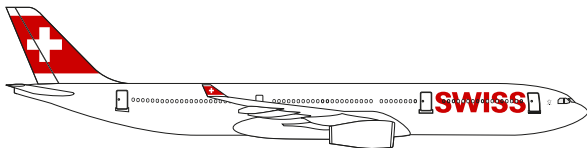

### Area of operation

North America, Asia, Africa, Middle East

### Capacity for cargo and mail

Up to 19 tons with full passenger load

### Weight and volume limitations

Compartments		1	2	3	4	5 Bulk	Security locker
Capacity	kg	9522	20412	14832	10206	3408	50
Combined max.	kg	22861		18507			
Volume	m <sup>3</sup>	80.5		62.6		19.6	0.09
Number of units		2 P or 6 C	4 P or 12 C	3 P or 8 C	2 P or 6 C		

Note: Max. weight per pallet 88 × 125" is 4625 kg, for pallet 96 × 125" 5100 kg.  
Variable pallet, container configuration.

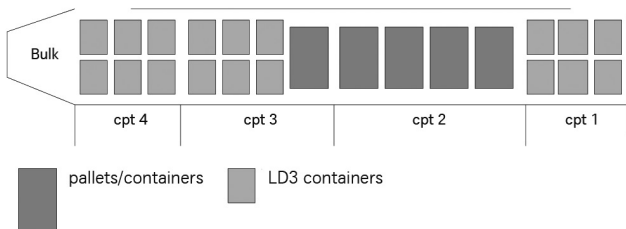

### Basic allocation for cargo and mail

5 pallets/containers

10 s

# Fleet

## Airbus A321-111 (321)

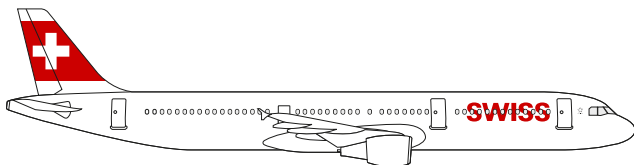

### Area of operation

Europe, North Africa, Middle East

### Capacity for cargo and mail

Up to 2.8 tons with full passenger load

### Weight and volume limitations

Compartments		1	2	3	4	5 Bulk	Security locker
Capacity	kg	2268	3402	3402	2268	1377	30
Volume	m <sup>3</sup>	7.0	10.5	10.5	7.0	5.2	0.036
Number of units		2 C	3 C	3 C	2C		

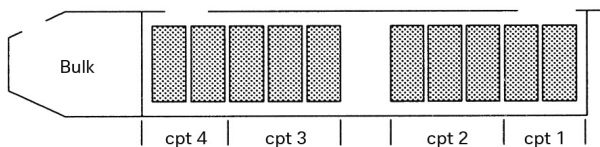

LD3-45 containers

### Basic allocation for cargo and mail

4 containers

# Fleet

## Airbus A321neo (32Q)

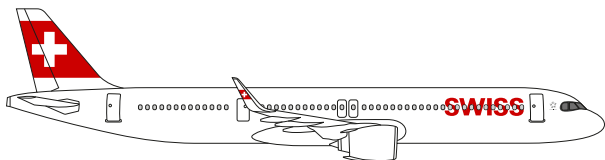

### Area of operation

Europe, North Africa, Middle East

### Capacity for cargo and mail

Up to 2.8 tons with full passenger load

### Weight and volume limitations

Compartments		1	2	3	4	5 Bulk	Security locker
Capacity	kg	2268	3402	3402	2268	1377	18
Volume	m <sup>3</sup>	7.0	10.5	10.5	7.0	5.2	0.035
Number of units		2 C	3 C	3 C	2C		

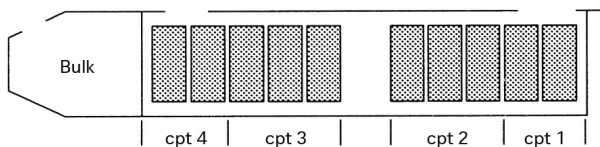

LD3-45 containers

### Basic allocation for cargo and mail

4 containers

# Fleet

## Airbus A320-214 (320)

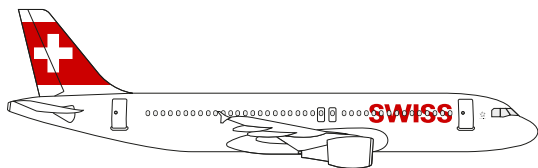

### Area of operation

Europe, North Africa, Middle East

### Capacity for cargo and mail

Up to 2.4 tons with full passenger load

### Weight and volume limitations

Compartments		1	3	4	5 Bulk	Security locker
Capacity	kg	3402	2268	2268	500*	30
Volume	m <sup>3</sup>	10.5	7.0	7.0	2.5*	0.09
Number of units		3 C	2 C	2 C		

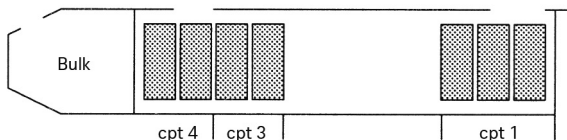

LD3-45 containers

### Basic allocation for cargo and mail

2 containers

\* Of which max 100 kg/0.5 m<sup>3</sup> for cargo and mail

# Fleet

## Airbus A320neo (32N)

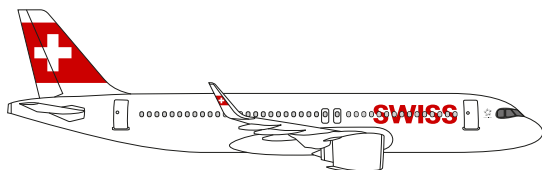

### Area of operation

Europe, North Africa, Middle East

### Capacity for cargo and mail

Up to 2.4 tons with full passenger load

### Weight and volume limitations

Compartments		1	3	4	5 Bulk	Security locker
Capacity	kg	3402	2268	2268	500*	30
Volume	m <sup>3</sup>	10.5	7.0	7.0	2.5*	0.09
Number of units		3 C	2 C	2 C		

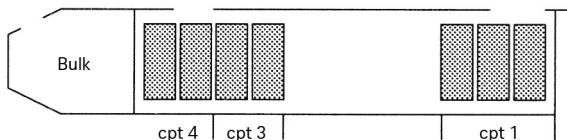

LD3-45 containers

### Basic allocation for cargo and mail

2 containers

\* Of which max 100 kg/0.5 m<sup>3</sup> for cargo and mail

# Fleet

## Airbus A220-100 (221)

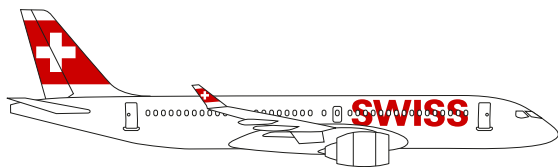

### Area of operation

Europe

### Capacity for cargo and mail

Up to 3 tons

### Weight and volume limitations

		Compartment 1	Compartment 4
Maximum mass	kg	1697	2063
Maximum combined load	kg	3760	
Volume	m <sup>3</sup>	8.81	11.69
Max. specific load (flat floor)	kg/m <sup>2</sup>	732	732
Max. specific load (curved floor)	kg/m <sup>2</sup>	293	293

Security locker available: 320 x 400 x 350 (mm)

Maximum weight of a single piece: 149 kg



# Fleet

## Airbus A220-100 (221)

### Maximum dimensions of packages

#### Forward Cargo Compartment

	Length (cm)														
<b>80</b>	248	233	223	210	203	193	185	177	172	165	157				
<b>78</b>	274	256	243	231	220	210	200	193	185	177	172				
<b>76</b>	294	276	259	246	233	223	213	203	195	187	180				
<b>73</b>	317	297	279	264	248	236	226	215	208	200	193				
<b>68</b>	363	337	314	294	276	264	251	238	228	218	210	203	195		
<b>63</b>	370	370	350	325	304	287	271	259	248	236	228	218	210		
<b>58</b>	370	370	370	355	332	312	294	279	264	254	243	233	223		
<b>50</b>	370	370	370	370	370	345	322	302	287	271	261	248	238		
<b>30</b>	370	370	370	370	370	370	355	332	312	297	281	269	256		
	<b>7</b>	<b>15</b>	<b>22</b>	<b>30</b>	<b>38</b>	<b>45</b>	<b>53</b>	<b>60</b>	<b>68</b>	<b>76</b>	<b>83</b>	<b>91</b>	<b>99</b>		
	Width (cm)														

#### Aft Cargo Compartment - Forward Section

	Length (cm)														
<b>80</b>	248	233	223	210	203	193	185	177	172	165	157				
<b>78</b>	274	256	243	231	220	210	200	193	185	177	172				
<b>76</b>	294	276	259	246	233	223	213	203	195	187	180				
<b>73</b>	317	297	279	264	248	236	226	215	208	200	193				
<b>68</b>	322	322	314	294	276	264	251	238	228	218	210	203	195		
<b>63</b>	322	322	322	322	304	287	271	259	248	236	228	218	210		
<b>58</b>	322	322	322	322	322	312	294	279	264	254	243	233	223		
<b>50</b>	322	322	322	322	322	322	322	302	287	271	261	248	238		
<b>30</b>	322	322	322	322	322	322	322	322	312	297	281	269	256		
	<b>7</b>	<b>15</b>	<b>22</b>	<b>30</b>	<b>38</b>	<b>45</b>	<b>53</b>	<b>60</b>	<b>68</b>	<b>76</b>	<b>83</b>	<b>91</b>	<b>99</b>		
	Width (cm)														

#### Aft Cargo Compartment - Aft Section

	Length (cm)														
<b>80</b>	241	231	218	208	198	193	185	177	172	165	157				
<b>78</b>	266	251	241	228	215	208	200	193	185	177	172				
<b>76</b>	281	269	254	243	231	220	210	200	195	187	180				
<b>73</b>	304	284	271	256	243	233	223	213	205	200	193				
<b>68</b>	345	320	302	284	271	256	243	236	226	215	208	200	195		
<b>63</b>	388	355	332	314	294	281	266	254	241	233	226	215	208		
<b>58</b>	406	396	363	340	322	302	284	271	259	246	238	231	220		
<b>50</b>	406	406	406	381	355	330	312	294	281	266	254	243	236		
<b>30</b>	406	406	406	406	396	365	342	322	304	287	276	261	251		
	<b>7</b>	<b>15</b>	<b>22</b>	<b>30</b>	<b>38</b>	<b>45</b>	<b>53</b>	<b>60</b>	<b>68</b>	<b>76</b>	<b>83</b>	<b>91</b>	<b>99</b>		
	Width (cm)														

# Fleet

## Airbus A220-300 (223)

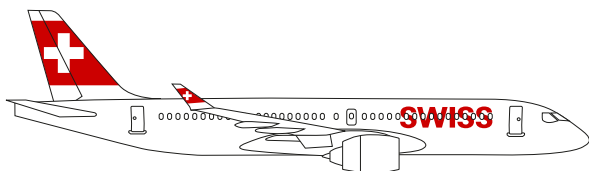

### Area of operation

Europe

### Capacity for cargo and mail

Up to 5 tons

### Weight and volume limitations

		Compartment 1	Compartment 4
Maximum mass	kg	2446	2606
Maximum combined load	kg	5052	
Volume	m <sup>3</sup>	13.08	14.92
Max. specific load (flat floor)	kg/m <sup>2</sup>	732	732
Max. specific load (curved floor)	kg/m <sup>2</sup>	293	293

Security locker available: 363 x 457 x 348 (mm)

Maximum weight of a single piece: 149 kg

Aircraft specification applicable as well for wet lease operation of airBaltic.

# Fleet

## Airbus A220-300 (223)

### Maximum dimensions of packages

#### Forward Cargo Compartment

Length (cm)													
<b>80</b>	248	233	223	210	203	193	185	177	172	165	157		
<b>78</b>	274	256	243	231	220	210	200	193	185	177	172		
<b>76</b>	294	276	259	246	233	223	213	203	195	187	180		
<b>73</b>	317	297	279	264	248	236	226	215	208	200	193		
<b>68</b>	363	337	314	294	276	264	251	238	228	218	210	203	195
<b>63</b>	411	378	350	325	304	287	271	259	248	236	228	218	210
<b>58</b>	462	419	386	355	332	312	294	279	264	254	243	233	223
<b>50</b>	541	482	436	401	370	345	322	302	287	271	261	248	238
<b>30</b>	584	568	505	457	416	383	355	332	312	297	281	269	256
	<b>7</b>	<b>15</b>	<b>22</b>	<b>30</b>	<b>38</b>	<b>45</b>	<b>53</b>	<b>60</b>	<b>68</b>	<b>76</b>	<b>83</b>	<b>91</b>	<b>99</b>
Width (cm)													

#### Aft Cargo Compartment - Forward Section

Length (cm)													
<b>80</b>	248	233	223	210	203	193	185	177	172	165	157		
<b>78</b>	274	256	243	231	220	210	200	193	185	177	172		
<b>76</b>	294	276	259	246	233	223	213	203	195	187	180		
<b>73</b>	317	297	279	264	248	236	226	215	208	200	193		
<b>68</b>	363	337	314	294	276	264	251	238	228	218	210	203	195
<b>63</b>	411	378	350	325	304	287	271	259	248	236	228	218	210
<b>58</b>	462	419	386	355	332	312	294	279	264	254	243	233	223
<b>50</b>	482	482	436	401	370	345	322	302	287	271	261	248	238
<b>30</b>	482	482	482	457	416	383	355	332	312	297	281	269	256
	<b>7</b>	<b>15</b>	<b>22</b>	<b>30</b>	<b>38</b>	<b>45</b>	<b>53</b>	<b>60</b>	<b>68</b>	<b>76</b>	<b>83</b>	<b>91</b>	<b>99</b>
Width (cm)													

#### Aft Cargo Compartment - Aft Section

Length (cm)													
<b>80</b>	241	231	218	208	198	193	185	177	172	165	157		
<b>78</b>	266	251	241	228	215	208	200	193	185	177	172		
<b>76</b>	281	269	254	243	231	220	210	200	195	187	180		
<b>73</b>	304	284	271	256	243	233	223	213	205	200	193		
<b>68</b>	345	320	302	284	271	256	243	236	226	215	208	200	195
<b>63</b>	388	355	332	314	294	281	266	254	241	233	226	215	208
<b>58</b>	406	396	363	340	322	302	284	271	259	246	238	231	220
<b>50</b>	406	406	406	381	355	330	312	294	281	266	254	243	236
<b>30</b>	406	406	406	406	396	365	342	322	304	287	276	261	251
	<b>7</b>	<b>15</b>	<b>22</b>	<b>30</b>	<b>38</b>	<b>45</b>	<b>53</b>	<b>60</b>	<b>68</b>	<b>76</b>	<b>83</b>	<b>91</b>	<b>99</b>
Width (cm)													

# Fleet

## Embraer 190 (E90)

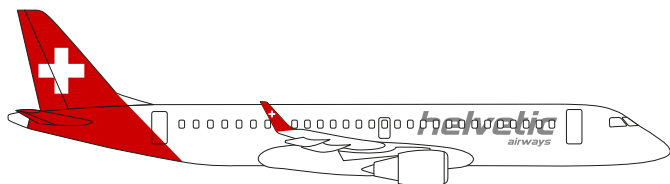

### Area of operation

Europe

### Capacity for cargo and mail

Up to 3.5 tons

(High passenger and luggage load substantially reduce the cargo/mail uplift.)

### Weight and volume limitations

		FWD Compartment	AFT Compartment
Maximum weight	kg	1696	1401
Usable Volume	m <sup>3</sup>	10.99	8.92
Maximum floor load	kg/m <sup>2</sup>	488	488

Security locker not available.

Maximum weight of a single piece: 149 kg

# Fleet

## Embraer 190 (E90)

### Maximum dimensions of packages

#### Forward Cargo Compartment

		Maximum Package Length (cm)							
		71	63	56	48	40	33	25	20
Height (cm)		302	250	215	150	140	140	130	120
		344	256	221	180	170	150	130	130
		483	396	294	215	180	170	150	130
		495	400	300	270	240	210	170	150
		500	410	310	280	240	210	190	160
		505	416	340	280	260	230	200	170
		510	448	348	290	260	230	200	170
		516	453	354	290	280	240	220	200
		570	570	366	311	280	270	220	200
		<b>13</b>	<b>25</b>	<b>38</b>	<b>51</b>	<b>63</b>	<b>76</b>	<b>89</b>	<b>101</b>
		Width (cm)							

#### Aft Cargo Compartment

		Maximum Package Length (cm)								
		56	48	40	33	25	20	13	13	
Height (cm)		400	340	270	230	200	195	145	145	
		450	340	280	235	200	195	150	145	
		450	340	280	240	210	200	155	145	
		460	350	290	257	210	200	163	159	
		470	360	320	260	230	210	170	162	
		470	380	340	319	250	230	190	179	
		470	450	420	380	350	300	250	210	
		<b>13</b>	<b>25</b>	<b>38</b>	<b>51</b>	<b>63</b>	<b>76</b>	<b>89</b>	<b>101</b>	
			Width (cm)							

# Fleet

## Embraer 190-E2 (290)

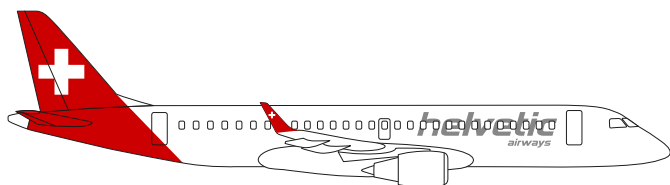

### Area of operation

Europe

### Capacity for cargo and mail

Up to 3.5 tons

(High passenger and luggage load substantially reduce the cargo/mail uplift.)

### Weight and volume limitations

		FWD Compartment	AFT Compartment
Maximum weight	kg	1590	1910
Usable Volume	m <sup>3</sup>	8.75	10.07
Maximum floor load	kg/m <sup>2</sup>	488	488

Security locker not available.

Maximum weight of a single piece: 149 kg

# Fleet

## Embraer 190-E2 (290)

### Maximum dimensions of packages

#### Forward Cargo Compartment

		Maximum Package Length (cm)							
		71	63	56	48	40	33	25	20
Height (cm)		302	250	215	150	140	140	130	120
		344	256	221	180	170	150	130	130
		483	396	294	215	180	170	150	130
		495	400	300	270	240	210	170	150
		500	410	310	280	240	210	190	160
		505	416	340	280	260	230	200	170
		510	448	348	290	260	230	200	170
		516	453	354	290	280	240	220	200
		570	570	366	311	280	270	220	200
		<b>13</b>	<b>25</b>	<b>38</b>	<b>51</b>	<b>63</b>	<b>76</b>	<b>89</b>	<b>101</b>
		Width (cm)							

#### Aft Cargo Compartment

		Maximum Package Length (cm)								
		56	48	40	33	25	20	13	13	
Height (cm)		400	340	270	230	200	195	145	145	
		450	340	280	235	200	195	150	145	
		450	340	280	240	210	200	155	145	
		460	350	290	257	210	200	163	159	
		470	360	320	260	230	210	170	162	
		470	380	340	319	250	230	190	179	
		470	450	420	380	350	300	250	210	
		<b>13</b>	<b>25</b>	<b>38</b>	<b>51</b>	<b>63</b>	<b>76</b>	<b>89</b>	<b>101</b>	
			Width (cm)							

# Fleet

## Embraer 195-E2 (295)

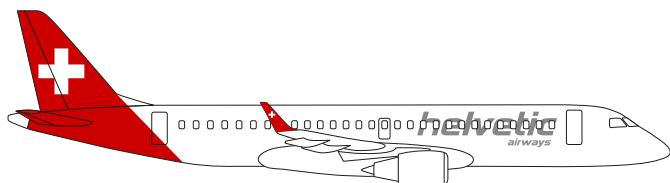

### Area of operation

Europe

### Capacity for cargo and mail

Up to 3.5 tons

(High passenger and luggage load substantially reduce the cargo/mail uplift.)

### Weight and volume limitations

		FWD Compartment	AFT Compartment
Maximum weight	kg	1590	1910
Usable Volume	m <sup>3</sup>	8.75	10.07
Maximum floor load	kg/m <sup>2</sup>	488	488

Security locker not available.

Maximum weight of a single piece: 149 kg



# Fleet

## Embraer 195-E2 (295)

### Maximum dimensions of packages

#### Forward Cargo Compartment

		Maximum Package Length (cm)							
		71	63	56	48	40	33	25	20
Height (cm)		302	250	215	150	140	140	130	120
		344	256	221	180	170	150	130	130
		483	396	294	215	180	170	150	130
		495	400	300	270	240	210	170	150
		500	410	310	280	240	210	190	160
		505	416	340	280	260	230	200	170
		510	448	348	290	260	230	200	170
		516	453	354	290	280	240	220	200
		570	570	366	311	280	270	220	200
		<b>13</b>	<b>25</b>	<b>38</b>	<b>51</b>	<b>63</b>	<b>76</b>	<b>89</b>	<b>101</b>
		Width (cm)							

#### Aft Cargo Compartment

		Maximum Package Length (cm)								
		56	48	40	33	25	20	13	13	
Height (cm)		400	340	270	230	200	195	145	145	
		450	340	280	235	200	195	150	145	
		450	340	280	240	210	200	155	145	
		460	350	290	257	210	200	163	159	
		470	360	320	260	230	210	170	162	
		470	380	340	319	250	230	190	179	
		470	450	420	380	350	300	250	210	
		<b>13</b>	<b>25</b>	<b>38</b>	<b>51</b>	<b>63</b>	<b>76</b>	<b>89</b>	<b>101</b>	
			Width (cm)							

# Fleet

## Edelweiss Airbus A320-214 (32E)



### Area of operation

Europe, North Africa, Middle East

### Weight and volume limitations

Compartments		1	3	4	5
Capacity	kg	3402	2426	2110	1497
Volume	m <sup>3</sup>	13.2	9.7	8.5	5.8
Total Capacity	9435 kg / 37.2 cm				
Max Floor Load	732 kg/m <sup>2</sup>				

### Loading possibilities

Max weight per piece	149 kg
ULD	Not Allowed
FREE LOAD	OK
BIG	See Charts
HEA	Need OK from CSD

### Compartment 1

Width cm	0	10	20	30	40	50	60	70	80	90	100	110	120	130	140	150	160	164
Heightrange 1-115 cm	435	415	395	375	355	335	315	294	247	254	234	214	194	173	165	143	143	143
Heightrange 1-97cm	475	475	475	455	435	414	394	374	354	334	314	294	273	253	233	212	200	200
Heightrange 1-70 cm	475	475	475	475	475	475	465	333	424	403	382	362	341	319	298	275	253	253
<b>Package Length in cm</b>																		

### Compartment 3 & 4

Width cm	0	10	20	30	40	50	60	70	80	90	100	110	120	130	140	150	160	171
Heightrange 1-115 cm	444	424	404	384	364	344	324	304	284	264	243	223	203	182	172	143	143	143
Heightrange 1-97cm	485	485	485	465	445	425	405	384	364	344	324	304	284	264	243	223	202	200
Heightrange 1-70 cm	485	485	485	485	485	485	475	355	435	414	394	373	352	331	310	288	266	253
<b>Package Length in cm</b>																		

# Unit Load Devices (ULD)

## Overview

ULD description (external dimensions in inches)	IATA code	Interior dimensions (length/width/height in cm)	Usable volume m <sup>3</sup> cu. ft	Maximum gross weight kg lbs	Interchangeability		
					333/343/77W	320/321	Selected truck routes

### Pallets

<b>96 inch</b>	P6P PMC	304x230x160	11.4 401	5103 11250	X		X
<b>88 inch</b>	P1P PAJ	304x210x160	10.3 366	4626 10198	X		X
<b>LD11</b>	PLA PLB	304x139x160	6.5 231	3175 7000	X		X
<b>60.4 inch*</b> (PKC)	PKC	145x143x114	2.1 73	1134 2500		X	X

### Containers

<b>LD9</b>	AMP	305x223x154	10.5 371	5103 11250	X		X
<b>LD3</b>	AKE	146x144x153	4.3 152	1587 3500	X		X
	AVA				X		X
<b>LD3-45</b>	AKH	145x143x111	3.6 127	1134 2500		X	X
<b>LD3-45</b> (Valuable cargo)	AKW	145x143x111	3.6 127	1134 2500		X	X

\* Through unit acceptable only within A320 family.

# Unit Load Devices (ULD)

## Overview

ULD description	IATA code	Interior dimensions (length/width/height in cm)	Usable volume m <sup>3</sup> cu. ft	Maximum gross weight kg lbs	Interchangeability		
					333/343/77W	320/321	Selected truck routes

### Envirotainer ICE cooling system

LD9	RAP (t2)	253x206x142	8.22 290.2	4626 10198 (incl. dry ice)	X		X
LD3	RKN (t2)	141x135x136	2.93 103.4	1587 3500 (incl. dry ice)	X		X

### Sonoco ThermoSafe Advanced Passive Temperature-Controlled ULD

LD3	AKP	122x102x122	1.5	1587 3500	X		X
-----	-----	-------------	-----	--------------	---	--	---

### Envirotainer electric compressor cooling system

LD9	RAP (e2)	246x205x126	6.38 224.2	4626 10198	X		X
LD9	RAP (Releye)	246x205x132	6.60 233	4625 10196	X		X
LD11	RLP (Releye)	247x135x132	4.4 156	3175 6999	X		X
LD3	RKN (e1)	134x132x131	2.3 81.9	1587 3500	X		X

### CSafe

LD9	RAP	130x248x208	6.68 236	4626 10198	X		X
LD3	RKN	122x127x128	1.9 70	1587 3500	X		X

### DoKaSch

LD9	RAP	246x202x132	6.57 232	4626 10198	X		X
LD3	RKN	126x130x122	1.8 66	1587 3500	X		X

### Swiss Airtainer

LD3	RKN	137x130x132	2.4 84.7	1587 3500	X		X
-----	-----	-------------	-------------	--------------	---	--	---

# Unit Load Devices (ULD)

## Detailed information

### Remark

All figures are interior dimensions. The actual maximum net weight of each container depends on the structural weight limitations of the respective loading position in the aircraft.

### 96 inch pallet

IATA code:	PMC
Loadable:	333 / 343 / 77W
Usable loading area:	304 x 230 cm / 120 x 91 in
Max. height:	160 cm / 63 in
Tare weight:	110 kg / 242 lbs
Max. gross weight:	5103 kg / 11250 lbs

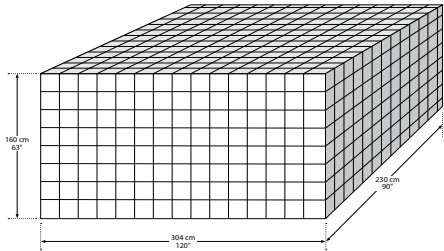

### 88 inch pallet

IATA code:	PAJ
Loadable:	333 / 343 / 77W
Usable loading area:	304 x 210 cm / 120 x 83 in
Max. height:	160 cm / 63 in
Tare weight:	110 kg / 242 lbs
Max. gross weight:	4626 kg / 10198 lbs

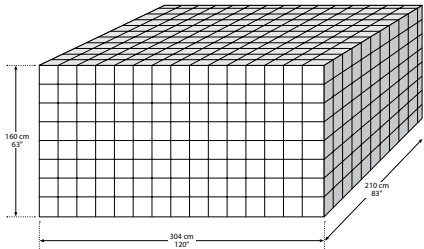

Weights depend on the structural weight limitations of the different pallet/container positions in the aircraft.  
Could be built higher, if route is truck operated only.

# Unit Load Devices (ULD)

## Detailed information

### LD11 pallet

IATA code:	PLA / PLB
Loadable:	333 / 343 / 77W
Usable loading area:	304 x 139 cm / 120 x 55 in
Max. height:	160 cm / 63 in
Tare weight:	90-116 kg / 198-255 lbs
Max. gross weight:	3175 kg / 7000 lbs

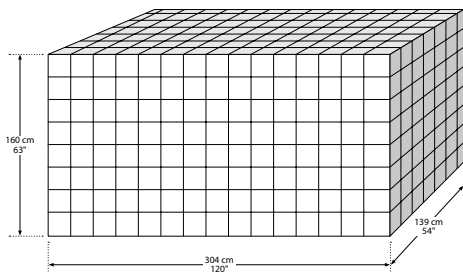

### 60.4 inch pallet

IATA code:	PKC
Loadable:	320 / 321
Usable loading area:	145 x 143 cm / 57 x 56 in
Max. height:	114 cm / 45 in
Tare weight:	40 kg / 88 lbs
Max. gross weight:	1134 kg / 2500 lbs

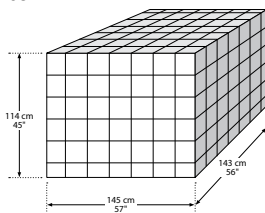

Could be built higher, if route is truck operated only.

# Unit Load Devices (ULD)

## Detailed information

### LD9 container

IATA code:	AMP
Loadable:	333 / 343 / 77W
Usable loading area:	305 x 223 cm / 120 x 88 in
Max. height:	154 cm / 61 in
Tare weight:	270 kg / 595 lbs
Max. gross weight:	5103 kg / 11250 lbs

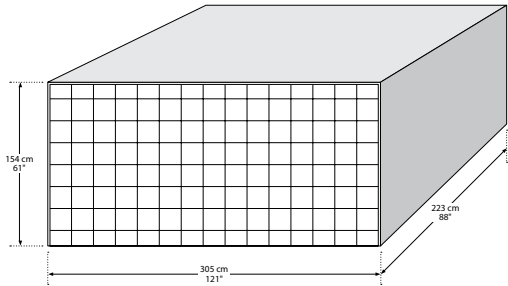

### LD3 container

IATA code:	AKE
Loadable:	333 / 343 / 77W
Usable loading area:	146 x 144 cm / 57 x 57 in
Max. height:	153 cm / 60 in
Top length:	193 cm / 76 in
Tare weight:	66-88 kg / 145-194 lbs
Max. gross weight:	1587 kg / 3500 lbs

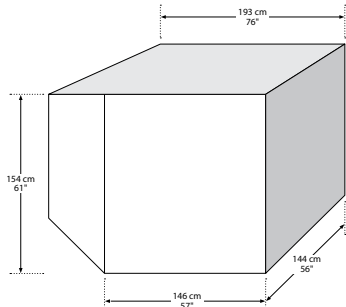

Weights depend on the structural weight limitations of the different pallet/container positions in the aircraft.

# Unit Load Devices (ULD)

## Detailed information

### LD3-45 container

IATA code:	AKH
Loadable:	320 / 321
Usable loading area:	145 x 143 cm / 57 x 56 in
Max. height:	111 cm / 44 in
Top Length:	243 cm / 96 in
Tare weight:	82 kg / 180 lbs
Max. gross weight:	1134 kg / 2500 lbs

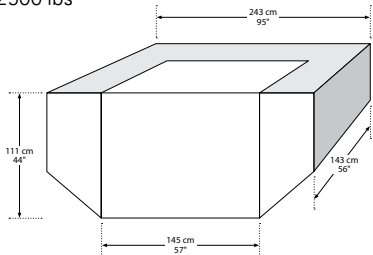

### LD3-45 container valuable cargo

IATA code:	AKW
Loadable:	320 / 321
Usable loading area:	145 x 143 cm / 57 x 56 in
Max. height:	100 cm / 39 in
Top Length:	243 cm / 96 in
Tare weight:	100 kg / 220 lbs
Max. gross weight:	1134 kg / 2500 lbs

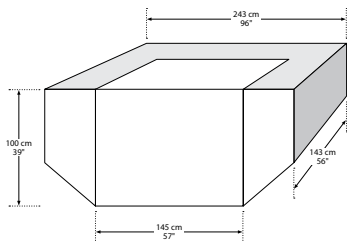



# Cooling Unit Load Devices

## Detailed information

### LD9 Envirotainer RAP t2

IATA code:	RAP
Loadable:	333 / 343 / 77W
Usable loading area:	253 x 206 cm / 100 x 81 in
Max. height:	142 cm / 56 in
Tare weight:	450 kg / 992 lbs
Max. gross weight:	4626 kg / 10198 lbs
Dry ice capacity:	300 kg 660 lbs
Temperature range:	-20 °C to +20 °C -4 °F to +68 °F

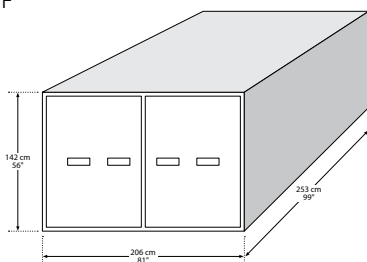

### LD3 Envirotainer RKN t2

IATA code:	RKN
Loadable:	333 / 343 / 77W
Usable loading area:	141 x 135 cm / 56 x 53 in
Max. height:	136 cm / 53 in
Tare weight:	265 kg / 584 lbs
Max. gross weight:	1587 kg / 3500 lbs
Dry ice capacity:	180 kg 397 lbs
Temperature range:	-20 °C to +20 °C -4 °F to +68 °F

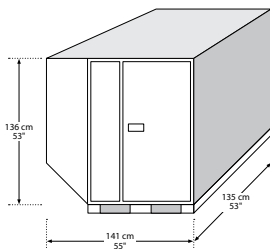

# Cooling Unit Load Devices

## Detailed information

### LD9 Envirotainer RAP e2

IATA code:	RAP
Loadable:	333 / 343 / 77W / truck
Usable loading area:	246 x 205 cm / 97 x 80 in
Max. height:	126 cm / 49 in
Tare weight:	1100 kg / 2425 lbs
Max. gross weight:	4626 kg / 10198 lbs
Recharging power supply:	100-240 V AC, 50-60 Hz
Maximum power consumption:	1850 W
Maximum charging time:	12 h
Temperature range:	0 °C to +25 °C +32 °F to +77 °F

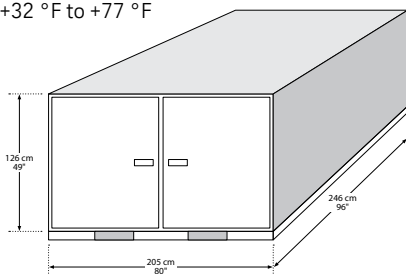

### LD9 Envirotainer Releye RAP

IATA code:	RAP
Loadable:	333 / 343 / 77W / truck
Usable loading area:	246 x 205 cm / 97 x 80 in
Max. height:	132 cm / 52 in
Tare weight:	1100 kg / 2425 lbs
Max. gross weight:	4625 kg / 10196 lbs
Recharging power supply:	100-240 V AC, 50-60 Hz
Maximum power consumption:	1850 W
Maximum charging time:	11 h
Temperature range:	+5 °C and +20 °C +41 °F and +68 °F

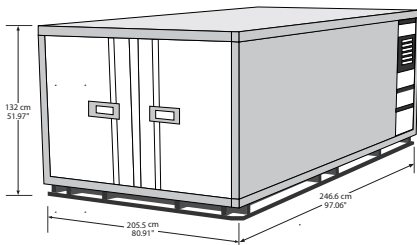

# Cooling Unit Load Devices

## Detailed information

### LD11 Envirotainer Releye RLP

IATA code:	RLP
Loadable:	333 / 343 / 77W / truck
Usable loading area:	247 x 135 cm / 97 x 55 in
Max. height:	132 cm / 52 in
Tare weight:	880 kg / 1940 lbs
Max. gross weight:	3175 kg / 6999 lbs
Recharging power supply:	100-240 V AC, 50-60 Hz
Maximum charging time:	11 h
Temperature range:	+5 °C and +20 °C +41 °F and +68 °F

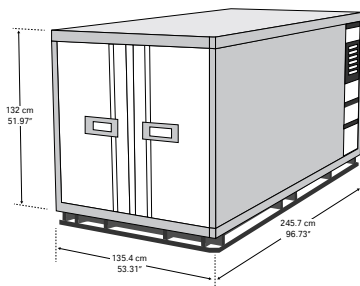

### LD3 Envirotainer RKN e1

IATA code:	RKN
Loadable:	333 / 343 / 77W / truck
Usable loading area:	134 x 132 cm / 52 x 51 in
Max. height:	131 cm / 51 in
Tare weight:	635 kg / 1399 lbs
Max. gross weight:	1587 kg / 3500 lbs
Recharging power supply:	100-240 V AC, 50-60 Hz
Maximum power consumption:	1850 W
Maximum charging time:	8 h
Temperature range:	0 °C to +20 °C +32 °F to +68 °F

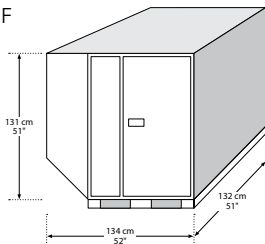

# Cooling Unit Load Devices

## Detailed information

### LD3 Sonoco ThermoSafe, Pegasus

IATA code:	AKP
Loadable:	333 / 343 / 77W / truck
Usable loading area:	122 x 102 cm / 48 x 40 in
Max. height:	122 cm / 48 in
Tare weight:	616 kg / 1358 lbs
Max. gross weight:	1588 kg / 3500 lbs
Temperature range:	+2 °C to +8 °C +36 °F to +46 °F

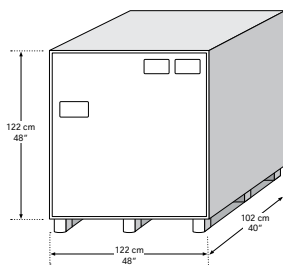

# Cooling Unit Load Devices

## Detailed information

### LD9 CSafe RAP

IATA code:	RAP
Loadable:	333 / 343 / 77W / truck
Usable loading area:	248 x 208 cm / 98 x 82 in
Max. height:	130 cm / 51 in
Tare weight:	1213 kg / 2675 lbs
Max. gross weight:	4626 kg / 10198 lbs
Recharging power supply:	100-240 V AC, 50-60 Hz
Maximum charging time:	approx. 10 h
Temperature range:	+4 °C to +25 °C +39 °F to +77 °F

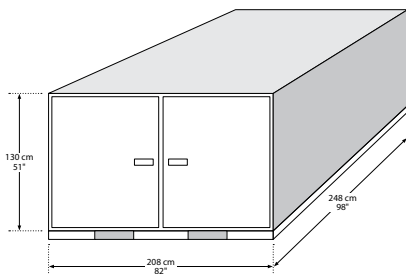

### LD3 CSafe RKN

IATA code:	RKN
Loadable:	333 / 343 / 77W / truck
Usable loading area:	121 x 127 cm / 47 x 50 in
Max. height:	127 cm / 50 in
Tare weight:	646 kg / 1424 lbs
Max. gross weight:	1587 kg / 3500 lbs
Recharging power supply:	100-240 V AC, 50-60 Hz
Maximum charging time:	approx. 6 h
Temperature range:	+4 °C to +25 °C +39 °F to +77 °F

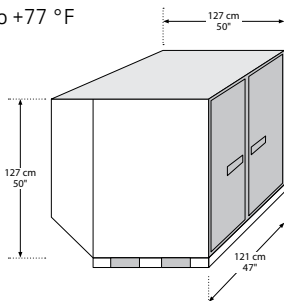

# Cooling Unit Load Devices

## Detailed information

### LD9 DoKaSch RAP

IATA code:	RAP
Loadable:	333 / 343 / 77W / truck
Usable loading area:	246 x 202 cm / 97 x 79 in
Max. height:	132 cm / 52 in
Tare weight:	1140 kg / 2513 lbs
Max. gross weight:	4626 kg / 10198 lbs
Recharging power supply:	110-220 V AC, 50-60 Hz (special cables needed)
Maximum charging time:	approx. 6 h
Temperature range:	+2 °C to +30 °C +36 °F to +86 °F

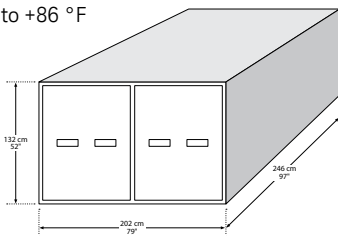

### LD3 DoKaSch RKN

IATA code:	RKN
Loadable:	333 / 343 / 77W / truck
Usable loading area:	126 x 130 cm / 49 x 51 in
Max. height:	122 cm / 48 in
Tare weight:	670 kg / 1477 lbs
Max. gross weight:	1587 kg / 3500 lbs
Recharging power supply:	110-220 V AC, 50-60 Hz (special cables needed)
Maximum charging time:	approx. 6 h
Temperature range:	+2 °C to +30 °C +36 °F to +86 °F

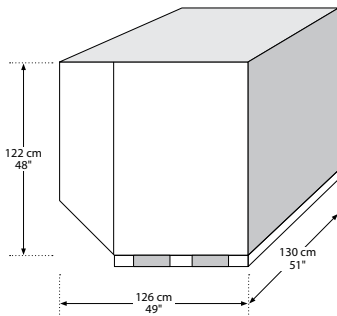

# Cooling Unit Load Devices

## Detailed information

### LD3 Swiss Airtainer

IATA code:	RKN
Loadable:	333 / 343 / 77W / truck
Usable loading area:	137 x 130 x 132 cm
Max. height:	132 cm
Tare weight:	390 kg / 859 lbs
Max. gross weight:	1587 kg / 3500 lbs

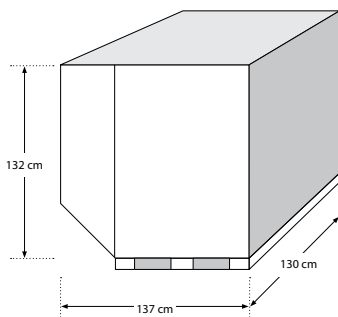

# Packagings

## Detailed information

### va-Q-case Half Euro (only on request)

IATA code:	JYP6
Loadable:	320 / 321 / 333 / 343 / 77W / truck
Usable loading area:	60 x 34 cm / 23 x 13 in
Max. height:	47 cm / 18 in
Tare weight:	113 kg / 249 lbs

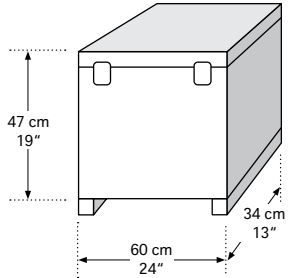

### va-Q-tainer Eurox

IATA code:	JYP5
Loadable:	333 / 343 / 77W / truck
Usable loading area:	120 x 85 cm / 47 x 33 in
Max. height:	117 cm / 46 in
Tare weight:	440 kg / 970 lbs

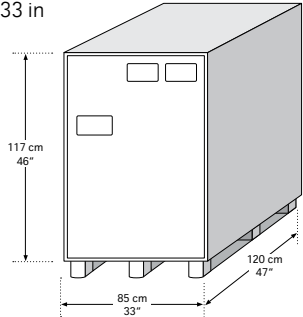

### va-Q-tainer USx

IATA code:	JYP4
Loadable:	333 / 343 / 77W / truck
Usable loading area:	120 x 125 cm / 47 x 49 in
Max. height:	117 cm / 46 in
Tare weight:	578 kg / 1274 lbs

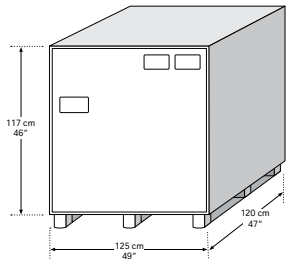



# Packagings

## Detailed information

### 19.va-Q-tainer XLx

IATA code:	JYP3
Loadable:	333 / 343 / 77W / truck
Usable loading area:	164 x 125 cm / 64 x 49 in
Max. height:	122 cm / 48 in
Tare weight:	660 kg / 1455 lbs

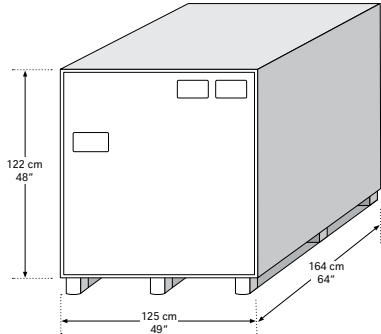

### va-Q-tainer TwinX

IATA code:	JYP3
Loadable:	333 / 343 / 77W / truck
Usable loading area:	211 x 125 cm / 83 x 49 in
Max. height:	122 cm / 48 in
Tare weight:	800 kg / 1763 lbs

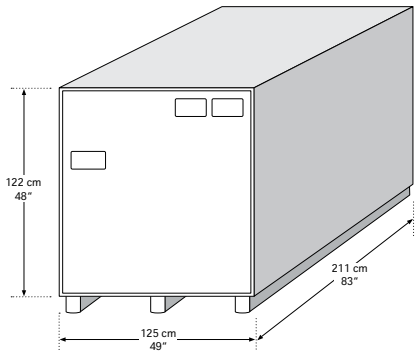

# Insurance

## General information

### Remark

Swiss International Air Lines Ltd.'s door-to-door cargo insurance (summary – terms and conditions of the insurance are subject to change without prior notice).

### Introduction

We do of course our utmost to deliver your shipment safely and in time to its destination. In spite of the best care given, goods may get stolen, lost or damaged in transit, we therefore recommend you to insure your cargo against such risks. For this purpose, SWISS holds an open cover with Delvag Versicherungs-AG, Venloer Strasse 151-153, 50672 Cologne Germany.

### Insurable value

The insurable value corresponds to the value of the goods at the place and time of commencement of the insured voyage, plus freight, insurance and other charges incurred up to the place of destination. In respect of trade goods, the value thus determined may be increased by the buyer's expected profit not exceeding 10% unless otherwise agreed. If there are no trade goods involved, the material cost, together with freight and the insurance premium, may be insured. Customs and excise duty may also be insured by special agreement.

### Maximum sum insured

The maximum sum that can be insured for any one consignment is CHF 1 000 000 or the equivalent in foreign currency. For watches, jewellery, genuine pearls (including culture pearls), precious stones and other jewels as well as mobile phones different conditions apply, which can be requested at: [cargo.claims@swiss.com](mailto:cargo.claims@swiss.com) or [aircargo@delvag.de](mailto:aircargo@delvag.de). The maximum sum insured may be increased by special agreement prior to the commencement of the risk.

To arrange insurance in excess of the above maxima, contact Swiss World-Cargo, Claims Management, P.O. Box ZRHS/LB-OS, CH-8058 Zurich Airport, [cargo.claims@swiss.com](mailto:cargo.claims@swiss.com) or [aircargo@delvag.de](mailto:aircargo@delvag.de). Allow time to consult the insurers/re-insurers of at least 3 working days.

# Insurance

## Goods of all kinds

### Insurance cover goods of all kinds

Air cargo shipments of any kind may be insured on a worldwide basis via the SWISS Air Waybill within the terms and conditions of the open policy concluded between SWISS and Delvag. For species (valuable goods) as per insurer's definition see "Insurance cover species (valuables)" below.

### Scope of insurance

The insurance is against all risks of damage or loss as per the special conditions of the open cover for goods.

Watches, jewellery, genuine pearls (including culture pearls), precious stones and other jewels: during the time the goods are in the custody of the assured, consignor or consignee, except in those cases where they are acting in the capacity of a carrier, the insurer is liable for loss only if it is the direct consequence of one of the following events:

violence threatened or used against the person charged with effecting the carriage or inability of those persons to offer resistance as a result of accident or death, specified accident in accordance with the general conditions. During intermediate stops: burglary occurring in locked rooms of massive buildings.

Livestock, perishable goods (plants, fruits, flowers, blood plasma, vaccines, meat, pharmaceutical, chemical, etc.), removal goods and vehicles have a special cover, please inquire with Swiss WorldCargo, Claims Management, P.O. Box ZRHS/LB-OS, CH-8058 Zurich Airport, cargo.claims@swiss.com.

Unless otherwise agreed, war, strike, disturbances and terrorism risks are not included.

### Duration of insurance

The insurance is operative from warehouse to warehouse. It begins when the goods are delivered to the transporters (forwarding agents, post office, railway, airline) or their agents and sub-carriers, and terminates on delivery to the consignee named in the air waybill or insurance certificate, or to the final consignee designated by same.

For shipments of goods, collection from or delivery to the airports is covered, even when undertaken by the consignee or consignor.

Notwithstanding anything to the contrary contained elsewhere in the summary mobile phones are only covered from airport to airport by air.

# Insurance

## Goods of all kinds

Note:

Transport to the airport of departure is only insured on condition that a specific request to this effect is made to LX or an IATA agent before commencement of the risk (i.e. on advice of shipment).

Delays in the execution of the insured voyages is limited to 60 days any one delay.

### Security measures (surface)

For goods with high values (watches, jewellery, precious stones, etc.) adequate security measures must be provided for transportation from shipper's domicile to the airport of departure and from the airport of destination to the consignee's domicile.

### Forwarding instruction (air)

Each consignment by aircraft with a value of CHF 10 000.– or higher each kilogramme gross has to be forwarded as "Valuable Cargo".

Watches, jewellery, genuine pearls (including culture pearls), precious stones and other jewels: each package by aircraft with a value of CHF 25 000.– or higher has to be forwarded as "Valuable Cargo".

Mobile phones: each consignment by aircraft has to be sent as SWISS Argus. If SWISS Argus is not available for a certain destination the consignment has to be forwarded as "Valuable Cargo". Forwarding as "Valuable Cargo" has also to be complied with if the value per each package by aircraft is in excess of CHF 25 000.– or if the value of the consignment by aircraft is in excess of CHF 200 000.–.

### Insurance premium

The premium is calculated on the basis of the insurance value. The minimum per insured consignment is CHF 20.– or the equivalent in other currencies.

### Insurance zones

Zone 1: Europe, including European part of Turkey

Zone 2: North America, including Mexico

Zone 3: Central and South America

Zone 4: Africa

Zone 5: Asia, including Asian part of Turkey /  
Middle East / Australia and Oceania

# Insurance

## Goods of all kinds

### Tariff "goods of all kinds"

Zone	1	2	3	4	5
	‰	‰	‰	‰	‰
<b>1</b>	1.0	1.5	3.0	2.5	2.5
<b>2</b>	1.5	1.0	3.0	2.5	2.5
<b>3</b>	3.0	3.0	2.5	3.0	3.0
<b>4</b>	2.5	2.5	3.0	2.5	2.5
<b>5</b>	2.5	2.5	3.0	2.5	2.0

‰ per mille of the insurable value

### Special premiums for all routes

- Removal goods and personal effects (shipped as cargo) 9.00‰
- Fragile and delicate goods (glass, porcelain, stoneware, sculptures, glassware, pottery, etc.) 8.00‰
- Vehicles (cars, motorcycles, etc.)  
Base premiums plus 50.00%
- Livestock 30.00‰
- Perishable goods (plants, fruits, flowers, meat, pharmaceutical, chemical, etc.) 30.00‰
- Frozen goods 7.50‰
- Refrigerated goods 12.00‰
- Watches
- Mobile phones  
Base premium plus 50%

### Additional premiums

- For delays exceeding 60 days, for each additional period of 30 days commenced 1.0‰
- For war, strikes, disturbance and terrorism on request
- For overland transport to/from the airport of departure/destination in excess of 750 km or 450 miles each 1.0‰

# Insurance

## Species (SWISS Valuables)

### Insurance cover species (SWISS Valuables)

Valuable cargo means a consignment which contains more of the following articles:

1. Any article having a declared value for carriage of USD 1'000.00 (or its equivalent) or more, per gross kilogram.
2. Gold bullion (including refined and unrefined gold in ingot form), dore bullion, gold specie, B. Gold only in the form of grain, sheet, foil, powder, sponge, wire, rod, tube, circles, mouldings and castings, A. Platinum, platinum metals (palladium, iridium, ruthenium, osmium and rhodium), Platinum alloys in the form of grain, sponge, bar, ingot, sheet, rod, wire, gauze, tube and strip, provided that those radioactive isotopes of the above metals and alloys are dangerous goods.
3. Legal bank notes, traveller's cheque, securities, shares and share coupons, postage stamps and revenue stamps (excluding mint), ready for use bank cards and/or credit cards.
4. A. Diamonds (including diamonds for industrial use), rubies, emeralds, sapphires, opals and real pearls (including cultured pearls), I B. Jewelry consisting of any of the articles under A. above.
5. Jewelry and watches made of platinum and/or gold and/or silver, and
6. Articles made of platinum and/or gold, other than platinum and/or gold plated.

# Insurance

## Species (SWISS Valuables)

### Scope of insurance

The insurance covers loss or damage as per the special conditions of the open cover for species. In the case of accompanied consignments, theft and loss are only insured if violence is threatened or used or if no resistance can be offered as a result of death or injury of the person charged with effecting the carriage.

Unless otherwise agreed, war, strike, disturbances and terrorism risks are not included.

### Duration of insurance

The insurance is operative from warehouse to warehouse, It attaches as soon as the species/valuables are removed from their present place for immediate transportation and terminates as soon as they are delivered to the place specified by the consignee.

For shipment of species, collection from or delivery to the airports is covered, even when undertaken by the consignee or consignor.

Note:

Transport to the airport of departure is only insured on condition that a specific request to this effect is made to LX or an IATA air cargo agent before commencement of the risk (i.e. on advice of shipment).

Storage during transit is covered up to 60 days any one storage.

### Security measures (land)

For species adequate security measures for overland transports will be required (security vans and/or armored cars) under consideration of the insured value of the species. Please inquire with Swiss WorldCargo, Claims Management, P.O. Box ZRHS/LB-OS, CH-8058 Zurich Airport.

### Forwarding instruction (air)

Species have to be forwarded as "valuable cargo". They must be expressly indicated as "VAL" in the AWB and SWISS Worx and must be handled according to current CHM instructions.

# Insurance

## Species (SWISS Valuables)

### Insurance premium

The premium is calculated on the basis of the insurance value. The minimum per insured consignment is CHF 20.– or the equivalent in other currencies.

### Insurance zones

Zone 1: Europe, including European part of Turkey

Zone 2: North America, including Mexico

Zone 3: Central and South America

Zone 4: Africa

Zone 5: Asia, including Asian part of Turkey /  
Middle East / Australia and Oceania

### Tariff "species" (SWISS Valuables)

Zone	1	2	3	4	5
	‰	‰	‰	‰	‰
1	0.5	0.75	2.5	1.75	2.0
2	0.75	0.5	2.5	1.75	2.0
3	2.5	2.5	2.0	2.5	2.5
4	1.75	1.75	2.5	1.75	2.0
5	2.0	2.0	2.5	2.0	1.75

‰ per mille of the insurable value

### Additional premiums

- For delays exceeding 60 days, for each additional period of 30 days commenced 1.0‰
- For war and strikes, disturbances and terrorism on request
- For overland transport to/from the airport of departure/destination in excess of 750 km or 450 miles each on request 1.0‰



# Insurance

## Exclusions and claims

### General exclusions (extract of the conditions)

The consequences of confiscation, seizure or detention by a government, authority or power, delay howsoever caused, in transit or delivery, wilful misconduct of the assured, infringement of import, export or transit regulations, infringement of carrier's regulations, false declaration.

Also excluded is damage attributable to: humidity of the air, influence of temperature unless specially agreed prior to the commencement of the risk, the nature of the goods such as self-deterioration, heating, spontaneous combustion, shrinkage, wastage, vermin originating in the goods insured, unsuitable condition of the goods for the insured voyage, inadequate packing, normal wear and tear, damage caused by nuclear energy, indirect losses of all kinds such as loss of interest, difference of exchange, loss of market, consequential loss. The insurer is released from all liability if his regulations concerning dispatch and limits are not adhered to or if with the insured's knowledge the agreed safety measures are not adhered to, the journey or the means of conveyance do not correspond to the agreement, the species are carried by inappropriate vehicles or routes are used which are unsuitable. Unless otherwise agreed prior to the commencement of the risk the insurer is not liable for political or social risks such as war, warlike occurrences, strike, lockout and disturbances of whatever kind, violent or malicious acts. The risk of terrorism for all transport related delays/storages exceeding 60 days. For permanent storage the risk of terrorism is generally excluded.

### What to do in case of loss or damage

The assured must notify the insurer without any delay of any loss or damage which comes to his knowledge.

Furthermore, in the event of loss or damage it is the duty of the assured to take forthwith all measures for the preservation and salvage of the goods and for minimising the loss or damage.

The insurer also may take such measures. In the event of non-compliance with these obligations, the indemnification can be reduced commensurate with the assured's degree of fault.

All rights of recovery against third parties who may be held responsible for the loss or damage shall be preserved. In particular, the following steps are to be taken:

- a. Outward apparent loss or damage must be notified to the carrier in writing before delivery of the goods is taken.
- b. Whenever loss or damage is presumed, valid reserves must be lodged within the period prescribed by law or by contract.
- c. The carrier must be summoned to a joint survey of the loss or damage. The assured is responsible for all acts or omissions which prejudice the right of recovery.

# Insurance

## Exclusions and claims

### Claim regulations

To justify his title to claim for loss or damage, the claimant must provide the insurer with such original documents as are available, i.e.:

- Air waybill
- Commercial invoice, packing list (inventory indicating values, if no commercial shipment involved)
- Survey report by the carrier
- Copy of the notification of reserves to the carrier
- And, if available:
  - Insurance certificate
  - Survey report by the claim agent

Claim documents shall be sent by the claim-receiving LX representation to Swiss WorldCargo, Claims Management, P.O. Box ZRHLX/CSS, CH-8058 Zurich Airport, for processing with the insurers.

### Separate legal indication

The insurance is based on the following conditions:  
Institute Cargo Clauses

This policy shall be governed by the German law and the German courts shall have sole jurisdiction in any dispute arising hereunder. In case one provision contradicts such applicable law, only this provision shall be deemed void, all other provisions remain in force as agreed.

Transport to the airport of departure is only insured on condition that a specific request to this effect is made to SWISS or an IATA Cargo Agent before commencement of the risk (i.e. on advice of shipment)

Place of jurisdiction is Cologne (Germany). All rights against the insurer are forfeited unless suit is brought within two years of the event giving rise to the claim.

### Further information

Further information is available from your nearest representation of Swiss WorldCargo or from the Head Office of Swiss WorldCargo in Zurich – Swiss WorldCargo, Claims Management, P.O. Box ZRHS/LB-OS, CH-8058 Zurich Airport, [cargo.claims@swiss.com](mailto:cargo.claims@swiss.com)

# Your cargo contacts

## Swiss WorldCargo offices

- **Ahmedabad**  
India  
☎ +91 79 26464504  
☎ +91 79 26466764  
☎ +91 79 26466813  
cargo.ahmedabad@swiss.com
- **Amsterdam**  
Netherlands  
☎ +31 20 8090 466  
cargo.netherlands@swiss.com
- **Athens**  
Greece  
☎ +30 210 35 43 898/9  
cargo.greece@swiss.com
- **Atlanta**  
USA  
☎ +1 724 572 82 77  
cargo.atlanta@swiss.com
- **Bangkok**  
Thailand  
☎ +66 2 134 3039  
cargo.thailand@swiss.com
- **Barcelona**  
Spain  
☎ +34 91 312 07 50  
cargo.spain@swiss.com
- **Basel/Mulhouse/  
Freiburg**  
Switzerland  
☎ +41 61 582 24 70  
☎ +41 61 582 18 95  
cargo.basel@swiss.com  
Import  
☎ +41 61 325 24 40  
☎ +41 61 325 24 56
- **Beijing**  
China  
☎ +86 10 6945 0450  
☎ +86 10 6945 0449  
cargo.beijing@swiss.com
- **Belgrade**  
Republic of Serbia  
c/o Sky Cargo Group  
☎/☎ +381 11 2097 402  
cargo.serbia@swiss.com
- **Belo Horizonte**  
Brazil  
☎ +55 51 24455010  
cargo.brazil@swiss.com
- **Berlin**  
Germany  
Berlin  
☎ +49 69 69 710 0  
cargo.germany@swiss.com
- **Berne**  
Switzerland  
(for freight forwarders)  
☎ +41 848 80 20 00  
☎ +41 44 564 53 33  
cargo.switzerland@swiss.com  
(for private customers)  
c/o Cargologic Ltd.  
☎ +41 31 381 79 86  
☎ +41 31 381 79 81  
cargo.export.berne@swiss.com  
Import  
☎ +41 31 381 79 79  
☎ +41 31 381 79 81  
cargologic.bern@swiss.com
- **Billund**  
Denmark  
c/o Airtrade  
☎ +45 3231 4286  
cargo.denmark@swiss.com
- **Birmingham**  
United Kingdom  
☎ +44 844 8888 724  
☎ +44 844 8888 725  
cargo.unitedkingdom@swiss.com
- **Bologna**  
Italy  
☎ +39 02 0070 3666  
cargo.italy@swiss.com
- **Bordeaux**  
France  
☎ +33 17 327 49 50  
☎ +33 141 846 814  
cargo.france@swiss.com
- **Boston**  
USA  
☎ +1 724 572 8244  
cargo.bos@swiss.com
- **Bratislava**  
Slovakia  
☎ +420 220 114 081  
cargo.czechrepublic@swiss.com
- **Bremen**  
Germany  
☎ +49 69 69 710 0  
cargo.germany@swiss.com
- **Brussels**  
Belgium  
☎ +32 2 257 03 30  
cargo.belgium@swiss.com
- **Bucharest**  
Romania  
c/o Kales Airline Services  
S.R.L.  
☎ +40 730 102 704  
cargo.romania@swiss.com
- **Budapest**  
Hungary  
☎ +36 29 789 901  
☎ +36 29 789 902  
☎ +36 29 789 904  
cargo.hungary@swiss.com
- **Buenos Aires**  
Argentina  
c/o Crossracer International SA  
Town Office  
☎ +54 11 4322 4222  
☎ +54 11 4328 9676  
Sales  
cargo.argentina@swiss.com  
Import Export  
swissworldcargo.handling.  
ar@crossracer.aero  
Airport Import  
☎ +54 11 5480 0157  
☎ +54 11 4897 4042  
cargo.argentina@swiss.com  
Airport Export  
☎ +54 11 4897 4040  
☎ +54 11 4897 4042  
cargo.argentina@swiss.com
- **Calgary**  
Canada  
☎ +1 514 422 8030  
cargo.canada@swiss.com
- **Cancun**  
Mexico  
☎ +1 724 572 8277  
cargo.mexico@swiss.com
- **Cape Town**  
South Africa  
☎ +27 11 390 2449  
☎ +27 71 377 7964  
(operation)  
cargo.southafrica@swiss.com
- **Chicago**  
USA  
☎ +1 724 572 8233  
cargo.ord@swiss.com
- **Cleveland**  
USA  
☎ +1 724 572 8233  
cargo.ord@swiss.com
- **Cologne**  
Germany  
☎ +49 69 69 710 0  
cargo.germany@swiss.com
- **Colombo**  
Sri Lanka  
☎ +94 11 243 54 03/4/5  
☎ +94 11 232 90 92  
cargo.srilanka@swiss.com
- **Copenhagen**  
Denmark  
c/o Airtrade  
☎ (+45) 3231 4286  
cargo.denmark@swiss.com
- **Cork**  
Ireland  
☎ +353 1 861 2276  
☎ +353 1 861 2257  
cargo.ireland@swiss.com
- **Curitiba**  
Brazil  
☎ +55 51 24455010  
cargo.brazil@swiss.com

# Your cargo contacts

- Delhi**  
India  
☎ +91 11 4705 7014 -18  
☎ +91 11 4705 7020  
cargo.delhi@swiss.com
- Denver**  
USA  
☎ +1 724 572 8255  
cargo.lax@swiss.com
- Detroit**  
USA  
☎ +1 724 572 8233  
cargo.ord@swiss.com
- Dhaka**  
Bangladesh  
☎ +880 2 895 6374  
☎ +880 2 883 5028  
cargo.bangladesh@swiss.com
- Dresden**  
Germany  
☎ +49 69 69 710 0  
cargo.germany@swiss.com
- Dubai**  
United Arab Emirates  
☎ +971 4 606 44 99  
☎ +971 4 299 15 23  
cargo.dubai@swiss.com
- Dublin**  
Ireland  
☎ +353 1 861 2276  
☎ +353 1 861 2257  
cargo.ireland@swiss.com
- Dusseldorf**  
Germany  
☎ +49 69 69 710 0  
cargo.germany@swiss.com
- Edinburgh**  
United Kingdom  
☎ +44 844 8888 724  
☎ +44 844 8888 725  
cargo.unitedkingdom@swiss.com
- El Paso**  
USA  
☎ +1 724 572 8255  
cargo.lax@swiss.com
- Florence**  
Italy  
☎ +39 02 0070 3666  
cargo.italy@swiss.com
- Florianopolis**  
Brazil  
☎ +55 51 24455010  
cargo.brazil@swiss.com
- Frankfurt**  
Germany  
☎ +49 69 69 710 0  
cargo.germany@swiss.com
- Geneva**  
Switzerland  
☎ +41 22 591 83 00  
cargo.geneva@swiss.com  
Import  
☎ +41 22 799 23 96
- Glasgow**  
United Kingdom  
☎ +44 844 8888 724  
☎ +44 844 8888 725  
cargo.unitedkingdom@swiss.com
- Gothenburg**  
Sweden  
c/o Air Trade Support  
☎ +46 8 59788 990  
cargo.sweden@swiss.com
- Graz**  
Austria  
☎ +43 1 395 092 40  
cargo.austria@swiss.com
- Hamburg**  
Germany  
☎ +49 69 69 710 0  
cargo.germany@swiss.com
- Hanoi**  
Vietnam  
c/o ECS Group  
☎ +84 4 3564 3719  
cargo.vietnam@swiss.com
- Hanover**  
Germany  
☎ +49 69 69 710 0  
cargo.germany@swiss.com
- Helsinki**  
Finland  
c/o Lufthansa Cargo  
☎ +44 844 8888 724  
cargo.unitedkingdom@swiss.com
- Ho Chi Minh City**  
Vietnam  
c/o ECS Group  
☎ +84 4 3225 2542  
☎ +84 8 3547 2151  
cargo.vietnam@swiss.com
- Hohenems/Dornbirn**  
Austria  
Sales Office import/export  
(for freight forwarders)  
SWISS Valuables  
☎ +41 848 80 30 00  
All other products  
☎ +41 848 80 20 00  
☎ +41 44 564 53 33  
cargo.switzerland@swiss.com
- Hong Kong**  
China  
☎ +852 2769 8725  
☎ +852 2764 6561  
cargo.hongkong@swiss.com
- Hyderabad**  
India  
☎ +91 98 4974 1000  
cargo.hyderabad@swiss.com
- Innsbruck**  
Austria  
☎ +43 1 395 092 40  
cargo.austria@swiss.com
- Johannesburg**  
South Africa  
☎ +27 11 390 2449  
☎ +27 71 377 7964  
(operation)  
cargo.southafrica@swiss.com
- Joinville**  
Brazil  
☎ +55 51 24455010  
cargo.brazil@swiss.com
- Kiev**  
Ukraine  
c/o FF Cargo Services  
☎/☎ +380 44 591 7894  
cargo.ukraine@swiss.com
- Kolkata/Calcutta**  
India  
☎ +91 33 4062 3210  
cargo.kolkata@swiss.com
- Krakow**  
Poland  
☎ +48 22 33 20 551/2/3  
cargo.poland@swiss.com
- Larnaca**  
Cyprus  
c/o LGS Handling  
☎ +357 2 4008500/1  
lca.cargo@lgshandling.com
- Las Palmas**  
Spain  
☎ +34 91 312 07 50  
cargo.greece@swiss.com
- Las Vegas**  
USA  
☎ +1 724 572 8255  
cargo.lax@swiss.com
- Leipzig/Halle**  
Germany  
☎ +49 69 69 710 0  
cargo.germany@swiss.com
- Lille**  
France  
☎ +33 17 327 49 50  
☎ +33 141 846 814  
cargo.france@swiss.com
- Lima**  
Peru  
☎ +1 724 572 8277  
cargo.mia@swiss.com
- LinZ**  
Austria  
☎ +43 1 395 092 40  
cargo.austria@swiss.com
- Lisbon**  
Portugal  
c/o Global Aviation Cargo  
☎ +35 1 963 174 856  
cargo.portugal@swiss.com
- Ljubljana**  
Slovenia  
☎ +43 1 395 092 40  
cargo.austria@swiss.com
- Lódź**  
Poland  
☎ +48 22 33 20 551/2/3  
cargo.poland@swiss.com

# Your cargo contacts

## London

United Kingdom  
☎ +44 844 8888 724  
☎ +44 844 8888 725  
cargo.unitedkingdom@swiss.com

## Los Angeles

USA  
☎ +1 724 572 8255  
cargo.lax@swiss.com

## Luxembourg

Luxembourg  
☎ +32 2 257 03 30  
cargo.belgium@swiss.com

## Lyon

France  
☎ +41 22 591 83 00  
☎ +41 22 799 23 76  
cargo.lyon@swiss.com

## Madrid

Spain  
☎ +34 91 312 07 50  
cargo.spain@swiss.com

## Málaga

Spain  
☎ +34 91 312 07 50  
cargo.spain@swiss.com

## Male

Maldives  
☎ +94 11 243 54 03/4/5  
☎ +94 11 232 90 92  
cargo.maldives@swiss.com

## Malmö

Sweden  
c/o Air Trade Support  
☎ +46 8 59788 990  
cargo.sweden@swiss.com

## Malta

Malta  
cargo.malta@swiss.com

## Manchester

United Kingdom  
☎ +44 844 8888 724  
☎ +44 844 8888 725  
cargo.unitedkingdom@swiss.com

## Marseille

France  
☎ +33 17 327 49 50  
☎ +33 141 846 814  
cargo.france@swiss.com

## Mauritius

Republic of Mauritius  
c/o Cel Aviation  
☎ +230 6379363  
☎ +230 637 9364  
cargo.mauritius@swiss.com

## Miami

USA  
☎ +1 724 572 8277  
cargo.mia@swiss.com

## Milan

Italy  
☎ +39 02 0070 3666  
cargo.italy@swiss.com

## Montreal

Canada  
☎ +1 514 422 8030  
cargo.canada@swiss.com

## Moscow

Russian Federation  
☎ +7 495 961 38 20  
cargo.russia@swiss.com

## Muenster/Osnabrueck

Germany  
☎ +49 69 69 710 0  
cargo.germany@swiss.com

## Mulhouse

France  
☎ +41 61 582 24 70  
☎ +41 61 582 18 95  
cargo.basel@swiss.com

## Mumbai/Bombay

India  
Reservation  
☎ +91 22 6177 4677/8  
Sales  
☎ +91 22 6177 4687/8  
☎ +91 22 6177 4666  
cargo.mumbai@swiss.com

## Munich

Germany  
☎ +49 69 69 710 0  
cargo.germany@swiss.com

## Muscat

Sultanate of Oman  
☎ +968 24 356 971  
cargo.oman@swiss.com

## Nantes

France  
☎ +33 17 327 49 50  
☎ +33 141 846 814  
cargo.france@swiss.com

## Naples

Italy  
☎ +39 02 0070 3666  
cargo.italy@swiss.com

## Navegantes

Brazil  
☎ +55 51 24455010  
cargo.brazil@swiss.com

## Newark

USA  
☎ +1 724 572 8222  
☎ +1 724 572 8223  
cargo.ewr@swiss.com

## New York (JFK)

USA  
☎ +1 724 572 8211  
☎ +1 724 572 8212  
cargo.jfk@swiss.com

## Nice

France  
☎ +33 17 327 49 50  
☎ +33 141 846 814  
cargo.france@swiss.com

## Nuremberg

Germany  
☎ +49 69 69 710 0  
cargo.germany@swiss.com

## Orlando

USA  
☎ +1 724 572 8277  
cargo.mia@swiss.com

## Osaka

Japan  
☎ +81 6 6347 8720  
cargo.japan@swiss.com

## Oslo

Norway  
Air Trade Support AS  
☎ +47 2240 3790  
cargo.norway@swiss.com

## Palma de Mallorca

Spain  
☎ +34 91 312 07 50  
cargo.spain@swiss.com

## Paris

France  
☎ +33 17 327 49 50  
☎ +33 141 846 814  
cargo.france@swiss.com

## Philadelphia

USA  
☎ +1 724 572 8222  
☎ +1 724 572 8223  
cargo.ewr@swiss.com

## Phnom Penh

Cambodia  
☎ +855 23 230 618  
☎ +855 12 503 898  
☎ +855 92 468 999  
cargo.cambodia@swiss.com

## Phoenix

USA  
☎ +1 724 572 8255  
cargo.lax@swiss.com

## Phuket

Thailand  
☎ +66 2 134 3039  
cargo.thailand@swiss.com

## Porto

Portugal  
c/o Global Aviation Cargo  
☎ +351 963 174 856  
cargo.portugal@swiss.com

## Porto Alegre

Brazil  
☎ +55 51 24455010  
cargo.brazil@swiss.com

## Prague

Czech Republic  
☎ +420 220 114 081  
cargo.czechrepublic@swiss.com

## Pristina

Kosovo  
☎ +381 38 59 58 177  
☎ +381 38 59 58 174  
cargoprnr@limakkosovo.aero

# Your cargo contacts

## **Punta Cana**

Dominican Republic  
☎ +1 809 959 0023  
☎ +1 809 221 1273  
cargo.dominicanrepublic@swiss.com  
Handling: puj.cargo@caribecargo.net

## **Rennes**

France  
☎ +33 17 327 49 50  
☎ +33 141 846 814  
cargo.france@swiss.com

## **Rio de Janeiro**

Brazil  
☎ +55 11 2445 5010  
ext. 218  
Reservation  
cargo.brazil@swiss.com  
Cargo Operations  
swissworldcargo.brazil@crossracer.com.br

## **Rome**

Italy  
☎ +39 02 0070 3666  
cargo.italy@swiss.com

## **Saint Petersburg**

Russian Federation  
c/o FF Cargo Services  
☎ +7 812 603 46 53  
☎ +7 495 648 65 01 (ext. 1)  
cargo.stpetersburg@swiss.com

## **Salt Lake City**

USA  
☎ +1 724 572 8255  
cargo.lax@swiss.com

## **Salzburg**

Austria  
☎ +43 1 395 092 40  
cargo.austria@swiss.com

## **San Diego**

USA  
☎ +1 724 572 8255  
cargo.lax@swiss.com

## **San Francisco**

USA  
☎ +1 724 572 8266  
☎ +1 724 572 8267  
cargo.sfo@swiss.com

## **San José**

Costa Rica  
c/o AmericasGSA  
☎ +1 506 8302 1133  
cargo.costarica@swiss.com

## **Santo Domingo**

Dominican Republic  
☎ +1 809 549 0111  
☎ +1 809 549 0552  
cargo.dominicanrepublic@swiss.com  
Export  
sdq.ops@caribecargo.net  
Import  
sdq.traffic@caribecargo.net

## **Santiago de Chile**

c/o HAE GSA  
☎ +56 2 3263 9420  
cargo.chile@swiss.com

## **São Paulo**

Brazil  
LX Sales Office  
☎ +55 11 2445 5010  
LX Cargo Operations  
☎ + 55 11 2445 6044  
ext. 218  
Reservation  
cargo.brazil@swiss.com  
Cargo Operations  
swissworldcargo.brazil@crossracer.com.br

## **Shanghai**

China  
☎ +86 21 6835 2190/2199  
ext. 187-191  
☎ +86 21 6835 2180  
cargo.shanghai@swiss.com

## **Shannon**

Ireland  
☎ +353 1 861 2276  
☎ +353 1 861 2257  
cargo.ireland@swiss.com

## **Singapore**

Singapore  
☎ +65 3157 0640  
☎ +65 6542 3611  
cargo.singapore@swiss.com

## **Skopje**

Austria  
☎ +43 1 7007 72400  
cargo.austria@swiss.com

## **Sofia**

Bulgaria  
c/o Globe Air Cargo  
cargo.bulgaria@swiss.com

## **Stockholm**

Sweden  
c/o Air Trade Support  
☎ +46 8 59788 990  
cargo.sweden@swiss.com

## **Strasbourg**

France  
☎ +41 61 582 24 70  
☎ +41 61 582 18 95  
cargo.basel@swiss.com  
Import  
☎ +33 3 67 65 00 40

## **Stuttgart**

Germany  
☎ +49 69 69 710 0  
cargo.germany@swiss.com

## **Taipei**

Taiwan  
☎ +886 2 2503 4123  
ext. 888  
☎ +886 2 2503 4122  
cargo.taiwan@swiss.com

## **Tampa**

USA  
☎ +1 724 572 8277  
cargo.mia@swiss.com

## **Tel Aviv**

Israel  
Export  
☎ +972 3 971 82 82  
☎ +972 3 972 10 32  
cargo.israel@swiss.com  
Import  
☎ +972 3 971 82 92  
☎ +972 3 972 10 32  
cargomp.israel@swiss.com

## **Tenerife South**

Spain  
☎ +34 91 312 07 50  
cargo.spain@swiss.com

## **Thessaloniki**

Greece  
Reservation  
☎ +30 210 3543898/9  
cargo.greece@swiss.com  
Operations  
☎ +30 2310 473823  
skg.cargoservices@swissport.gr

## **Tokyo**

Japan  
Reservation/Sales  
☎ +81 3 5405 4911  
cargo.japan@swiss.com

## **Toronto**

Canada  
☎ +1 905 676 3261  
cargo.toronto@swiss.com

## **Toulouse**

France  
☎ +33 17 327 49 50  
☎ +33 141 846 814  
cargo.france@swiss.com

## **Tucson**

USA  
☎ +1 724 572 8255  
cargo.lax@swiss.com

## **Turin**

Italy  
☎ +39 02 0070 3666  
cargo.italy@swiss.com

## **Valencia**

Spain  
☎ +34 91 312 07 50  
cargo.spain@swiss.com

## **Vancouver**

Canada  
☎ +1 514 422 8030  
cargo.canada@swiss.com

## **Venice**

Italy  
☎ +39 02 0070 3666  
cargo.italy@swiss.com

## **Verona**

Italy  
☎ +39 02 0070 3666  
cargo.italy@swiss.com

## **Vienna**

Austria  
☎ +43 1 395 092 40  
cargo.austria@swiss.com

# Your cargo contacts

## Warsaw

Poland

☎ +48 22 33 20 551/2/3

✉ cargo.poland@swiss.com

## Washington

USA

☎ +1 724 572 8222

☎ +1 724 572 8223

✉ cargo.ewr@swiss.com

## Wroclaw

Poland

☎ +48 22 33 20 551/2/3

✉ cargo.poland@swiss.com

## Zurich

Switzerland

Sales Office import/export

(for freight forwarders)

SWISS Valuables

☎ +41 848 80 30 00

All other products

☎ +41 848 80 20 00

☎ +41 44 564 53 33

✉ cargo.switzerland@swiss.

com

Export

(for private customers)

☎ +41 44 564 54 54

☎ +41 44 564 54 64

✉ cargo.export.zurich@

swiss.com